



Fashion STUDIES

Text Book

CLASS-XII



**CENTRAL BOARD OF
SECONDARY EDUCATION**

Preet Vihar, Delhi - 110301

नया आगाज़

आज समय की माँग पर
आगाज़ नया इक होगा
निरंतर योग्यता के निर्णय से
परिणाम आकलन होगा।

परिवर्तन नियम जीवन का
नियम अब नया बनेगा
अब परिणामों के भय से
नहीं बालक कोई डरेगा

निरंतर योग्यता के निर्णय से
परिणाम आकलन होगा।

बदले शिक्षा का स्वरूप
नई खिले आशा की धूप
अब किसी कोमल-से मन पर
कोई बोझ न होगा

निरंतर योग्यता के निर्णय से
परिणाम आकलन होगा।

नई राह पर चलकर मंज़िल को हमें पाना है
इस नए प्रयास को हमने सफल बनाना है
बेहतर शिक्षा से बदले देश, ऐसे इसे अपनाए
शिक्षक, शिक्षा और शिक्षित
बस आगे बढ़ते जाएँ
बस आगे बढ़ते जाएँ
बस आगे बढ़ते जाएँ.....





Fashion Studies



Textbook

CLASS

XII



CENTRAL BOARD OF SECONDARY EDUCATION

Shiksha Kendra, 2, Community Centre, Preet Vihar, Delhi-110 301 India





Text Book on Fashion Studies Class–XII

Price: ₹

First Edition 2014, CBSE, India

Copies:

**"This book or part thereof may not be reproduced by
any person or agency in any manner."**

Published By : The Secretary, Central Board of Secondary Education,
Shiksha Kendra, 2, Community Centre, Preet Vihar, Delhi-110301

Design, Layout : Multi Graphics, 8A/101, W.E.A. Karol Bagh, New Delhi-110005
Phone: 011-25783846

Printed By :



भारत का संविधान

उद्देशिका

हम, भारत के लोग, भारत को एक सम्पूर्ण ¹ [प्रभुत्व-संपन्न समाजवादी पंथनिरपेक्ष लोकतंत्रात्मक गणराज्य] बनाने के लिए, तथा उसके समस्त नागरिकों को:

सामाजिक, आर्थिक और राजनैतिक न्याय,
विचार, अभिव्यक्ति, विश्वास, धर्म
और उपासना की स्वतंत्रता,
प्रतिष्ठा और अवसर की समता

प्राप्त कराने के लिए

तथा उन सब में व्यक्ति की गरिमा

और ² [राष्ट्र की एकता और अखंडता]

सुनिश्चित करने वाली बंधुता बढ़ाने के लिए

दृढ़संकल्प होकर अपनी इस संविधान सभा में आज तारीख 26 नवम्बर, 1949 ई० को एतद् द्वारा इस संविधान को अंगीकृत, अधिनियमित और आत्मार्पित करते हैं।

1. संविधान (बयालीसवां संशोधन) अधिनियम, 1976 की धारा 2 द्वारा (3.1.1977) से “प्रभुत्व-संपन्न लोकतंत्रात्मक गणराज्य” के स्थान पर प्रतिस्थापित।
2. संविधान (बयालीसवां संशोधन) अधिनियम, 1976 की धारा 2 द्वारा (3.1.1977) से “राष्ट्र की एकता” के स्थान पर प्रतिस्थापित।

भाग 4 क

मूल कर्तव्य

51 क. मूल कर्तव्य - भारत के प्रत्येक नागरिक का यह कर्तव्य होगा कि वह -

- (क) संविधान का पालन करे और उसके आदर्शों, संस्थाओं, राष्ट्रध्वज और राष्ट्रगान का आदर करे;
 - (ख) स्वतंत्रता के लिए हमारे राष्ट्रीय आंदोलन को प्रेरित करने वाले उच्च आदर्शों को हृदय में संजोए रखे और उनका पालन करे;
 - (ग) भारत की प्रभुता, एकता और अखंडता की रक्षा करे और उसे अक्षुण्ण रखे;
 - (घ) देश की रक्षा करे और आह्वान किए जाने पर राष्ट्र की सेवा करे;
 - (ङ) भारत के सभी लोगों में समरसता और समान भ्रातृत्व की भावना का निर्माण करे जो धर्म, भाषा और प्रदेश या वर्ग पर आधारित सभी भेदभाव से परे हों, ऐसी प्रथाओं का त्याग करे जो स्त्रियों के सम्मान के विरुद्ध हैं;
 - (च) हमारी सामासिक संस्कृति की गौरवशाली परंपरा का महत्त्व समझे और उसका परिरक्षण करे;
 - (छ) प्राकृतिक पर्यावरण की जिसके अंतर्गत वन, झील, नदी, और वन्य जीव हैं, रक्षा करे और उसका संवर्धन करे तथा प्राणिमात्र के प्रति दयाभाव रखे;
 - (ज) वैज्ञानिक दृष्टिकोण, मानववाद और ज्ञानार्जन तथा सुधार की भावना का विकास करे;
 - (झ) सार्वजनिक संपत्ति को सुरक्षित रखे और हिंसा से दूर रहे;
 - (ञ) व्यक्तिगत और सामूहिक गतिविधियों के सभी क्षेत्रों में उत्कर्ष की ओर बढ़ने का सतत प्रयास करे जिससे राष्ट्र निरंतर बढ़ते हुए प्रयत्न और उपलब्धि की नई उंचाइयों को छू ले;
- ¹(ट) यदि माता-पिता या संरक्षक है, छह वर्ष से चौदह वर्ष तक की आयु वाले अपने, यथास्थिति, बालक या प्रतिपाल्य के लिये शिक्षा के अवसर प्रदान करे।

1. संविधान (छयासीवां संशोधन) अधिनियम, 2002 की धारा 4 द्वारा (12.12.2002) से अंतः स्थापित।

THE CONSTITUTION OF INDIA

PREAMBLE

WE, THE PEOPLE OF INDIA, having solemnly resolved to constitute India into a ¹[**SOVEREIGN SOCIALIST SECULAR DEMOCRATIC REPUBLIC**] and to secure to all its citizens :

JUSTICE, social, economic and political;

LIBERTY of thought, expression, belief, faith and worship;

EQUALITY of status and of opportunity; and to promote among them all

FRATERNITY assuring the dignity of the individual and the² [unity and integrity of the Nation];

IN OUR CONSTITUENT ASSEMBLY this twenty-sixth day of November, 1949, do **HEREBY ADOPT, ENACT AND GIVE TO OURSELVES THIS CONSTITUTION.**

1. Subs, by the Constitution (Forty-Second Amendment) Act. 1976, sec. 2, for "Sovereign Democratic Republic" (w.e.f. 3.1.1977)
2. Subs, by the Constitution (Forty-Second Amendment) Act. 1976, sec. 2, for "unity of the Nation" (w.e.f. 3.1.1977)

THE CONSTITUTION OF INDIA

Chapter IV A

FUNDAMENTAL DUTIES

ARTICLE 51A

Fundamental Duties - It shall be the duty of every citizen of India-

- (a) to abide by the Constitution and respect its ideals and institutions, the National Flag and the National Anthem;
- (b) to cherish and follow the noble ideals which inspired our national struggle for freedom;
- (c) to uphold and protect the sovereignty, unity and integrity of India;
- (d) to defend the country and render national service when called upon to do so;
- (e) to promote harmony and the spirit of common brotherhood amongst all the people of India transcending religious, linguistic and regional or sectional diversities; to renounce practices derogatory to the dignity of women;
- (f) to value and preserve the rich heritage of our composite culture;
- (g) to protect and improve the natural environment including forests, lakes, rivers, wild life and to have compassion for living creatures;
- (h) to develop the scientific temper, humanism and the spirit of inquiry and reform;
- (i) to safeguard public property and to abjure violence;
- (j) to strive towards excellence in all spheres of individual and collective activity so that the nation constantly rises to higher levels of endeavour and achievement;
- ¹(k) who is a parent or guardian to provide opportunities for education to his/her child or, as the case may be, ward between age of six and fourteen years.

1. Ins. by the constitution (Eighty - Sixth Amendment) Act, 2002 S.4 (w.e.f. 12.12.2002)



Foreword

Fashion today is the key driving force in running not just a country's economy but in linking the country with its partners on different sides of the 'networked globe'.

The estimated worldwide designer wear market is worth 40 billion dollars with an annual growth rate of 9%.

Although, the Indian fashion industry is fairly nascent, it has grown in leaps and bounds over the past decade.

While globalization is not a new process, in India it has accelerated rapidly since the government has opened up the economy to foreign investments, allowing international brands to cater to the Indian domestic retail sector.

The Indian apparel market is calculated to be worth Rs. 20,000 crores but of which only one fourth is of branded apparel. With 81% of young Indian population below 45 years, this organized market share is expected to grow exponentially over the years. The overall apparel sector in India is estimated to grow to \$220 billion by year 2020.

Hence, the need of the growing fashion conscious consumer and the ongoing process of globalization, has paved the way for new job avenues and opportunities in the arena of fashion.

In response to the demands of the changing fashion industry, the subject 'Fashion Studies' was introduced in 2006 at Senior Secondary level as an independent elective. Today the apparel sector has taken a paradigm shift and in order to convene global competitiveness, CBSE has upgraded the inputs in the subject with edifying information and additional visuals for better understanding. The units explore fundamental concepts of fashion and its various elements, fashion history, pattern making and basics of garments making.

The student will have the option of electing for this subject in combination with other subjects. The book will be a valuable tool for an introductory course in vocational education or even business. The book can also be considered as an introductory book for those who want to know about fashion and its varied aspects.

(The subject for class XII has been developed in collaboration with NIFT (National Institute of Fashion Technology, Delhi). I place on record the suggest of Sh P. K.Gera, Director General, NIFT and Sr. Professor, Banhi Jha, Dean (Academics). The NIFT Faculty who have contributed as authors of various chapters are Sr. Prof. Banhi Jha, Professor Kripal Mathur, Prof. Vandana Narang, Ms. Nayanika Thakur Mehta, Ms. Anu Sharma and Ms. Anu Jain. Their effort is highly appreciated in this revised edition.

Vineet Joshi
Chairman, CBSE





Preface

Fashion theory and practices are built on an academic foundation where history, anthropology, sociology, psychology and economics intermingle to shed light on clothing as one of the three most essential needs of the human race. It is a visual indicator of the cultural identity of a country.

Fashion is a dynamic force which influences lifestyle choices made by consumers. It drives international trends in a multitude of areas from apparel, accessories, automobiles, cuisine, wellness, vacations and more. Glamour notwithstanding, fashion is a serious global business with high financial stakes. The increasing references to Indian textiles, clothing and culture on international fashion scenario are indicative of India being centre-stage on the global fashion map.

The current educational environment provides students with a wide range of subjects that are informative and also encourages individual aptitude. Many want to pursue non-traditional careers where creativity, problem-solving and business acumen integrate into an exciting combination. Fashion Studies introduced by CBSE at the 10+2 level as an elective academic subject, points in the direction of fashion as a creative and challenging career.

Fashion Studies offers insight into the components and processes of design, manufacturing, marketing in apparel and textiles. It encompasses the process from fibre to fabric, from concept to creation of garments. It provides an overview of fashion, an understanding of fabrics and surface techniques, design fundamentals and elements of garment-making.

Fashion Studies as a subject is envisaged to help students to make an informed decision about their future goals.

Sr. Prof Banhi Jha
Dean - Academic





Acknowledgements

CBSE

Mr. Vineet Joshi, IAS, Chairman
Dr. Sadhna Parashar, Prof. & Director (ART & I)
Ms Kshipra Verma, Education Officer

NIFT

Mr. Prem Kumar Gera, IAS
Sr. Prof Banhi Jha, Dean(Academic)

Anchor

Prof. Kripal Mathur

Contributors

1. History of Fashion : Sr. Prof. Banhi Jha
 2. Basic Pattern Development : Prof. Vandana Narang
 3. Elements of Fashion : Ms. Nayanika Thakur Mehta
and Ms. Anu Sharma
 4. Basics of Garment Making : Prof. Vandana Narang and Ms. Anu Jain
- 





Overview

Chapter 1: History of Fashion

Objectives of the course

- i. To explain the importance of history as a source of research on fashion
- ii. To provide an overview of history of fashion from ancient civilization to the present century
- iii. To explain the socio-cultural factors influencing costume
- iv. To familiarize students with the terminology of the fashion history

Course Content

- i. Introduction to history of fashion, sources of information
- ii. Factors affecting clothing - protection, ritualistic, identification, adornment
- iii. Origin and development of costume
 - a. Draped costume - Indian, Sumerian, Assyrian, Babylonian, Egyptian, Greco-Roman
 - b. War costume - Armour, techniques of construction, ancient war costumes, uniforms during World Wars, Oriental and Indian war costumes
- iv. Industrial Revolution - mechanical inventions, influence on India
- v. Effect of World Wars on fashion
- vi. Evolution of modern Indian fashion
- vii. Films and fashion

Learning outcome

After completion of the unit, the students shall be able to do the following:

- i. Explain the significance of studying fashion history as a source of research for developing new collections
- ii. Express their knowledge of history of clothing and costume
- iii. Express their understanding of the role of multiple factors influencing costume
- iv. Express their understanding of the effect of Industrial Revolution on clothing Industrial Revolution
- v. Use appropriate terminology related to fashion history





Chapter 2: Basic Pattern Development

Objective of the course

- i. To introduce students to Fashion Design through pattern development
- ii. To explain the importance of this skill that enables the designer to convert a design sketch into a three dimensional form
- iii. To develop basic blocks for bodice, sleeve and skirt
- iv. To understand and implement the concept and importance of test fits and to convert paper patterns into muslin ones

Course Content

- i. Methods of measuring body and dress form
- ii. Relationship of sizes and measurements
- iii. Tools of pattern making
- iv. Common terms used in pattern development
- v. Pattern development for womenswear - how patterns are developed; the importance of fit and methods of achieving it.
- vi. Basic bodice - how to develop it from standard measurement charts and test fit on the dress form.
- vii. Details like darts, seam allowance, notches, grain lines etc.
- viii. Details like armholes, necklines - V, U round, boat, square
- ix. How to develop a basic sleeve block
- x. How to develop a basic skirt block with one dart or two darts.
- xi. How to develop the basics of collar development - basic collars like Peter Pan and Chinese
- xii. Dart manipulation

Learning outcome

After finishing the course, the student shall be able

- i. To demonstrate understanding the basic skills of pattern making
- ii. To demonstrate understanding of the concept of fit and balance
- iii. To develop basic blocks from measurement charts and body measurements
- iv. To test fit and correct the fit of the pattern
- v. To develop patterns for simple designs using basic blocks





Chapter 3: Elements of Fashion

Objective of the course

- i. To introduce students to the basic segments in fashion clothing
- ii. To teach students about fashion, fashion centres, categories of clothing & trims.
- iii. To sensitize students about different items of garments in each category i.e. menswear, womenswear and childrenswear
- iv. To teach students the difference between high fashion and mass fashion
- v. To distinguish between custom made & ready to wear

Course Content

- i. Menswear, womenswear and kidswear
- ii. Menswear - shirts, trousers, formal jackets, suit and sporty suit
- iii. Womenswear - dresses, blouses, skirts, trousers, kameezes, saris & blouses
- iv. Kids wear - garments for different age categories (between 0-15) 'jhabla' frocks, skirts, blouses, trousers, dungarees, T-shirts highlighting the requirements of the age group for which they are designed.
- v. Trims used for the fashion apparel
- vi. High fashion - custom made and ready to wear garments
- vii. Mass fashion - ready to wear garments

Learning outcome

After finishing the course, the students shall be able to do the following:

- I. Demonstrate understanding the segments in fashion clothing
- ii. Demonstrate understanding and use of appropriate fashion terminologies
- iii. Exhibit knowledge about fashion centres
- iv. Demonstrate understanding of various categories of menswear, womenswear and childrenswear
- v. Demonstrate understanding of trims used in apparels
- vi. Demonstrate understanding of the difference between high fashion and mass-fashion, custom made and ready to wear clothing.





Chapter 4: Basics of Garment Making

Objectives of the course

- i. To teach students how to assemble a garment
- ii. To construct a bodice using different seams
- iii. To stitch a placket for bodice opening
- iv. To finish a neckline using piping and facing
- v. To set in a sleeve in the arm hole
- vi. To gather or pleat the skirt and finish the waistline with a waist band or a bodice

Learning outcome

After finishing the course, the students shall be able

- i. To assemble various parts of the garment and stitch a complete garment
- ii. To finish a bodice with suitable seam finishes
- iii. To set in the sleeve in the armhole
- iv. To assemble a skirt and finish the waistline suitably

Course content

- i. Understanding fabric types and selection of underlining, interfacing, inter-lining
- ii. Pattern making methods and preparing fabric for cutting
- iii. Pattern layout and cutting of special fabrics
- iv. Assembly of bodice using different seams and appropriate finish for side seam and shoulder seams
- v. Slit and seam plackets, type of plackets and placement of fasteners on different parts of garment
- vi. Appropriate neckline finishes with piping, bias facing and shaped facing. Important and use of stay stitching
- vii. Sleeve attachment to the bodice by setting in the sleeve into armhole
- viii. Assembling of skirt, finishing gathers and pleats into a waistband
- ix. Final product: Constructing skirt and blouse using pattern template

Teaching tools and techniques

Lectures and demonstrations supplemented with photographs, print clippings, slides, Power Point presentations



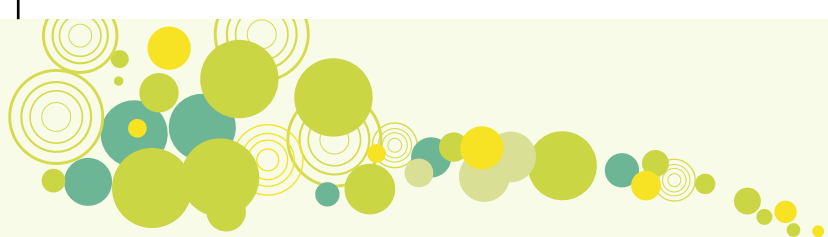

Contents

CHAPTER 1: HISTORY OF FASHION

1.1	Introduction	1
1.1.1	Sources of Information	2
1.1.2	Factors Affecting Clothing	3
	(i) Protection	3
	(ii) Ritualistic	4
	(iii) Adornment	5
	• Adornment through Clothes	5
	• Adornment through Body - Body Modification, Scarification, Tattooing and Body painting	6
	(iv) Identification	7
	• Identification of Social Status	8
	• Identification of Rank	9
	• Identification of Profession	9
	• Identification of Marital Status	9
	• Identification of Individual Status in a Tribe	9
1.2.	Origin and Development of Costume	11
	Draped Costumes	12
1.2.1	Indian Costume	12
1.2.2	Ancient Near East costume - Sumerian, Babylonian, Assyrian	14
1.2.3	Egyptian Costume	15
1.2.4	Greek Costume	16
1.2.5	Roman Costume	17
1.3.	War Costume and Uniforms	19
1.3.1	Armour	20
	(i) Techniques of Armour Construction	20
	(ii) Armour Accessories	21
1.3.2	Ancient War Costume	22





FASHION STUDIES



(i) Sumerian War Costume	22
(ii) Egyptian War Costume	23
(iii) Greek War Costume	23
(iv) Roman War Costume	23
(v) Medieval War Costume	24
1.3.3 Oriental and Indian War Costumes	25
(i) Japanese War Costume	25
(ii) Indian War Costume - Vedic, Kushan, Gupta, Rajput, Mughal, Indo-Persian	25
1.3.4. Uniforms During World Wars	27
(i) Influence of War Uniforms on Civilian Clothing	27
1.4 Industrial Revolution	30
1.4.1 Mechanical Inventions during Industrial Revolution	31
1.4.2 Influence of Industrial Revolution on India	32
1.5. Effect of World Wars on Fashion	34
1.5.1. World War I (1914-1918)	34
1.5.2 Between the Wars (1991-1939)	35
1.5.3 World War II (1939-1945)	37
1.6. Evolution of Modern Indian Fashion	39
1.7. Films and Fashion	49
 CHAPTER 2: BASIC PATTERN DEVELOPMENT	
2.1 Pattern Making	55
2.1.1 Introduction: Pattern Development & its Origin	55
2.1.2 Pattern Making	57
2.1.3 Terminology	58
2.1.4 Symbols and Abbreviations	64
2.2 Measurements	65
2.2.1 How to take Measurements	65
2.2.2 Standard Measurement Chart for Bodice & Skirt	70
2.2.3 Sizes and Measurements	71





2.3	Tools	73
2.3.1	Tools and Equipment	73
2.4	Fit	76
2.4.1	Garment Fitting	76
2.4.2	Evaluating Fit	78
2.4.3	Need to Fit	81
2.4.4	Methods of Fit	82
2.5	Pattern Development	83
2.5.1	Basic Bodice	83
2.5.2	Sleeveless Bodice	88
2.6	Necklines	89
2.6.1	Necklines & Variations	89
2.6.2	Finishing of Neckline	94
2.7	Dart Manipulation	95
2.7.1	Introduction	95
2.7.2	Slash & Spread Method	96
2.8	Skirt	99
2.8.1	Basic Skirt	99
2.8.2	One Dart basic Skirt	101
2.8.3	A-Line Skirt	102
2.8.4	Flared Skirt	103
2.9	Sleeve	104
2.9.1	Sleeve Block	104
2.10	Collar	106
2.10.1	Principles of Collar Development	106
2.10.2	Mandarin Collar	107
2.10.3	Peter Pan Collar	108
CHAPTER 3:		
3.1.1	Understanding Fashion - Definition and Overview	111
3.1.2	Haute Couture	112





3.1.3 High Fashion Ready-to-Wear	113
3.1.3.1 London	114
3.1.3.2 Milan	115
3.1.3.3 New York	115
3.1.3.4 Paris	116
3.1.3.5 Tokyo	117
3.1.3.6 Emergence of India as a Fashion Centre	117
3.1.4 Ready-to-Wear and Mass-Produced garments: Off-Shore Manufacturing	118
3.2.1 Introduction to Menswear	123
3.2.1.2 Categories in Menswear clothing	124
3.2.2 Colour in Menswear	125
3.2.3 Fabrics for Menswear	125
3.2.4 Classic Shirt and its types	125
3.2.5 Bottom wear - Pants	126
3.2.6 Shorts	128
3.2.7 Suits	128
3.2.8 Indian menswear fashion market today	130
3.3.1 Introduction to Womenswear	133
3.3.1.1 Influence of Trends on Womenswear	134
3.3.1.2 Indian Womenswear	134
3.3.2 Elements of Design in Womenswear	135
3.3.2.1 Colour	135
3.3.2.2 Fabric	135
3.3.2.3 Shape / Silhouettes	136
3.3.3 Garment Collections	136
3.3.3.1 Dresses	137
3.3.3.2 Blouses	137
3.3.3.3 Skirts	138
3.3.3.4 Pants	139
3.3.3.5 Kurta and Salwar	140
3.3.3.6 Sari Blouse	140





3.4.1	Introduction to Childrenswear	143
3.4.2	Newborns Clothing	144
3.4.3	Infants Clothing	144
3.4.4	Toddlers Clothing	145
3.4.5	Preteens and Teens Clothing	145
3.5.1	Introduction to Trims	149
3.5.2	Trim Classifications	149
3.5.2.1	Fastenings	149
3.5.2.2	Hardware	150
3.5.2.3	Zippers	150
3.5.2.4	Lacings	150
3.5.2.5	Linear Trims	151
3.5.2.6	Shaped Edges	151
3.5.2.7	Frills or Ruffles	152
3.5.2.8	Circular Ruffle	152
3.5.2.9	Braids, Ribbons and Rick racks	152
3.5.2.10	Appliqués and Patches	153
3.5.2.11	Studs	153
3.5.2.12	Heat-Transfer Prints	153

CHAPTER 4: BASIC GARMENT MAKING

4.1	Fibres and Fabrics	157
4.1.1	Categories of Fabrics	157
4.1.2	Characteristics of Fabrics	158
4.1.3	Underlying Fabrics	159
4.1.4	Selection of Underlying Fabric	160
4.2	Cutting Preliminaries	162
4.2.1	Fabric Preparation	162
4.2.2	Fabric Cutting	162
4.2.3	Grain Line	163
4.2.4	Preshrinking	164





FASHION STUDIES

4.2.5	Identifying Right Side of Fabric	165
4.2.6	Folding Fabrics for Cutting	165
4.2.7	Marking Methods	166
4.2.8	Pattern Layout	167
4.2.9	Computerized Marker Making	167
4.2.10	Cutting Special Fabrics	168
4.3	Placket	171
4.3.1	Continuous Placket	172
4.3.2	Simple Shirt Placket	174
4.3.3	Shirt Placket with Facing	176
4.3.4	Buttons Placement	177
4.4	Neckline Facings	179
4.4.1	Bias Strip	179
4.4.2	Preparation of Bias Strip	180
4.4.3	Neckline Finished with Bias Binding/Extended Facing	180
4.4.4	Neckline Finished with Bias Facing	182
4.4.5	Neck Line Finished with Shaped Facing	183
4.5	Sleeve Attachment	187
4.5.1	Steps of Construction of Sleeve	187
4.5.2	Cuffs	188





Chapter 1

History of Fashion

1. Introduction

In the previous book on 'Fashion Studies' for Std XI, the meaning of fashion and other aspects within its ambit has been discussed. In this book, we trace the history of clothing down the ages and how it facilitates the understanding of contemporary fashion.

At the onset it is important to understand that though the words fashion, clothing, apparel and costume are often used interchangeably, the terms are not identical in meaning.

Fashion is more than just clothing; it reflects the wider spectrum of aesthetics, art and design trends in contemporary society. This makes it a multi-faceted word engaging with a range of surrounding influences. In simple terms, *fashion is a social process by which newly introduced styles or trends become popular in a certain time with acceptability by a wider cross-section of consumers.*

Clothing is a general term referring to *actual objects related to the human body.*

Apparel refers to *garments made of fabric, knits, leather or other wearable materials.*

Costume is derived from word 'custom' evolving from the environment and customs of society. It refers to *clothing for a specific use - be it for a ritual or performance, ethnic or historical within a specific context of occasion and time.*

To understand contemporary fashion within a context, it is essential to know its origin and evolutionary process. The knowledge of fashion and costume history is important since they are the inevitable outcome of the socio-cultural-political influences prevalent in society at different points in time.

Clothes are what cover the human body, which in turn, depend on physical conditions like climate, geographical area, available raw material, textiles etc. Clothes indicate social significance like religious beliefs and aesthetics; exhibit individual status; proclaim alliance with or create differentiation among a group. Items of clothing and accessories would be included in the vocabulary of clothing.

There are several points of views regarding the origin and need for clothing. One school of thought believes that man covered his body for protecting himself from the vagaries of climate and nature. Psychologists and ethnologists refer to psychological reasons like the fig leaf used by Adam and Eve as a symbol of modesty referred to in the Bible. Anthropologists cite reasons associated with taboo as well as the desire for personal



adornment to please both oneself and others. Psychologists propound the view that human being like to modify their appearance - the use of body covering is one such type of modification. Other ways for achieving this is through varying hairstyles, alteration of shape and surface of the body through clothes, body adornment etc. Such changes are done in order to make the self, more acceptable to others so that there is a commonality and bonding with the others within the same social 'tribe'.

Primitive men covered their body with animal skin and fur which were shaped to parts of the human body. Different sizes, shapes and textures of skins would have necessitated varying approaches to their use and function when applied to cover or adorn the human figure. Later they used tree bark fibre to protect themselves against extremities of climate. However clothes are not merely utilitarian but have a deeper significance. The co-relation between the belief of primitive men in magic and representation of successful hunting through cave paintings dates back to the early Paleolithic period. Even today, certain tribes that normally live naked also wear clothes on special occasions!

1.1.1. Sources of Information

In prehistoric times the lifestyle of humans changed according to changes in climate, which also influenced costume. Remnants of their clothing have been found in valleys and caves. Tools, costumes and accessories travelled along the trade routes which were extended and defined in the Bronze and Iron Ages. It is assumed that fur, stones etc. may have been bartered in different societies. The predominant use of animal skins would have been necessitated by the need for warmth. The skins were scraped and the fur was combed. The eyed-needle of bone or horn was used for assembly of pieces threaded by long manes and tails of horses as well as split reindeer tendons. Few vestiges of clothing from early ages remain, since cloth made of vegetable fibre like rushes (grass), linen etc. are perishable. Archaeology uses the most scientific methods on surviving specimens of prehistoric textiles to extract the fullest information about the materials and manufacturing techniques.



Fig 1.1 Necklace, Bronze Age, Paris, Musee des Antiquities Nationales

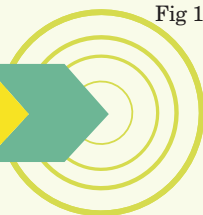



Fig 1.2 Roman sandals discovered in London. First century AD.
The London Museum. (Museum Photo)

1.1.2 Factors Affecting Clothing

Sociologists, anthropologists and psychologists have tried to explain the motivation for wearing clothes. Fashion historian James Laver, has propounded three principles of Seduction, Utility and Hierarchy which govern clothing. Other historians have propounded 4 different explanations regarding the importance of the following factors:

- i) Protection
- ii) Rituals
- iii) Identification
- iv) Adornment

(i) Protection

Several scholars say that the need for clothing was born out of physical necessity. Men required clothing in response to the need for protection and for shelter against extreme variations of temperature, rain, dust, thorns, wild animals and insects. For activities like warfare and hunting, extra protection was needed for the body. Eskimos wear closely fitted garments in several layers to effectively trap and retain body warmth. They wear a fur garment which is so suited for the freezing cold that European explorers of the Arctic have adopted similar garments like fur-lined parkas. Pastoral people like Turkoman and Kirghiz wear three or four bulky padded Caftan-like coats with sheepskin over-jackets for protection against the bitter Central Asian winter.

Wearing several layers of clothing is also seen in areas of high temperature where it is



important to prevent the body from becoming dehydrated under the blazing sun. The Tuareg of the Sahara and the Bedou of Saudi Arabia wear long robes and loose trousers in light, cool cotton for protection and air circulation. In parts of Saudi Arabia and Africa, men protect themselves with a loose head-covering which can cover their heads, mouth and nostrils for protection against dust and sand, revealing only the eyes.

It is important to understand that the indigenous clothing in different parts of the world use locally available materials utilizing the craft skills of the people. Examples are leather garments made by tribes, by cleaning of the leather either by scraping away excess animal fat sticking to it and then softening it by rubbing animal fat, or even by mastication (chewing). The Ainu of North Japan & Siberian Gilayak use fish skins to make waterproof garments.

The natives who live in the cool temperate zones near on the North West coast of Canada, wear short poncho-like rain capes of shredded cedar barks and conical wide brimmed waterproof woven hats, for protection against heavy rainfall. Bark fibre is preferable over animal skins in moist, tropical areas since it dries more easily.

(ii) **Rituals**

Primitive man believed that certain costumes could endow special attributes and would protect him from evil. Certain parts of animals like claws, hooves and teeth worn as accessories, were believed to enhance the wearer's strength and imbue with the characteristics of that creature. In Egypt, the lion's tail and claws being symbolic of bravery, vigour and shrewdness were an important part of the Pharaoh's regalia.

Sometimes, the hunter felt that wearing hooves and horns may transmit enviable qualities of that animal. Eventually through auspicious association, he adopted a certain animal as his symbol and this became a family totem or crest through inheritance. This was publicized by the use of their symbols on aprons, blankets or on totem poles.

From earliest times, articles of clothing were also worn to ward off the evil eye. They believed that only magic could help. to combat malignant forces around. For women, the greatest fear or curse was that of sterility. To counteract this, cowry shells which resembled a woman's reproductive organs, were used in clothing and accessories. It is the same belief that caused both positive and modern men to wear amulets, rings and other adornments, which would act as good luck charms.

Certain costumes and ornaments also identify the wearer with gods, heroes and other men. For primitive people, this identification was factual (for heroes) while in contemporary times, it is more symbolic. Theatre, which has its origin in ancient times,

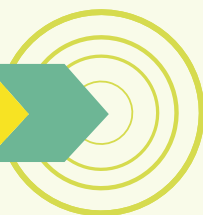



ranges from simple play-acting by children at play, home or at school, to the more sacred performances in Greco-Roman and Oriental / Asian plays. In theatre, costumes appear to 'disguise' the wearer's individuality and transform him into a different persona or even a 'God'.

Some costumes are associated with religious significance. A religious head or priest can be recognized by specific clothes, which proclaim his religious role and authority. Believers and followers of different religions have distinctive clothes and/or accessories for reasons of respect, actual or symbolic identification with God and the need to express those emotions in their mortal existence.

(iii) Adornment

Beautification of the self through decoration of clothes or of the body itself, has been the pre-occupation of humans since ancient times.

❁ Adornment through clothes

While the prime function of clothing is self-protection, indication of social status, wealth, age and occupation, humans also pander to their self-vanity which enhance their physical attributes. In primitive and tribal societies, people used easily available indigenous and natural materials as diverse as feathers, seeds, sea shells, wood, precious stones, animal parts like teeth, bone, fur, feathers etc. selected on the basis of colour, texture and shape. They also discovered methods of crafting the materials like tanning of hides, weaving dyeing, and printing of fabrics for decoration in clothing.

History has instances where the desire for adornment occasionally transcends practical concerns like comfort and wearability. When ostentation and exaggeration dominate other factors, the resultant look may become distinctive but impractical. An example of this is the shoe called 'poulaine' worn in medieval times. Originating in France, this shoe extended to such exaggerated lengths that it had to be held in the hand while walking or else tied back to the ankle with a ribbon until laws were passed restricting the length of the toe to 6" for commoners, 12" for gentlemen and 24" for nobility and royalty.

In 18th century England, an exaggerated mode of clothing was that of tight breeches for men which made it difficult for them to even sit down.

The 19th century Victorian corset created the desirable tiny waist size. However the constant constriction of the ribcage made even the simple act of breathing very difficult.



Fig 1.3. Long-toed Poulaines, Victoria and Albert museum, London



Fig 1.4 Corset

In 18th century Europe, women's skirts expanded tremendously in width and therefore had to be supported by layers of petticoats, which made mobility very cumbersome. The panier, a lighter supporting frame made of graduated oblong-shaped boned hoops stitched to an underskirt made the skirt so wide on either side of the hips that doors and stairways had to be widened to enable the wearer to pass through.

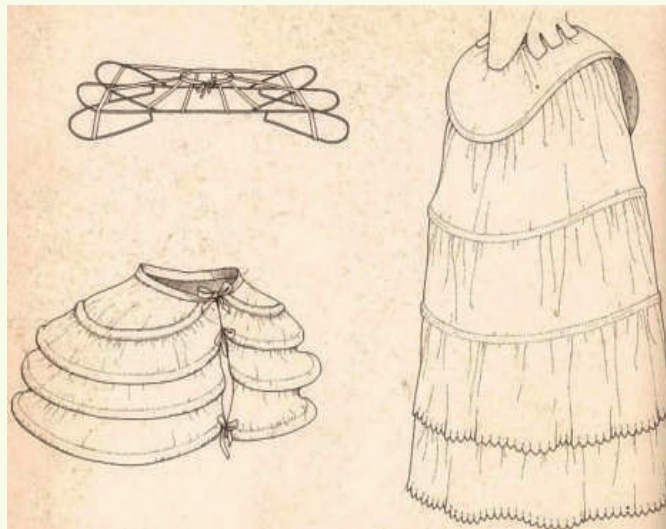

Fig 1.5: Panier understructure



Fig 1.6: Understructure worn under the voluminous court gown.
(Moreau Le Jeune: Les Adieux, 1777, Monument du Costume, Paris, BibliothequeNationale)

❁ Adornment of the body

The concept of beautification of the body has been a variable factor in different societies and at different periods in history. This is done through 4 different methods of Body Modification, Scarification, Tattooing and Body painting.

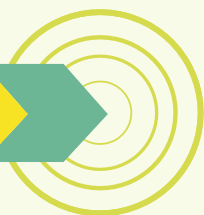



- ❖ **Body modification** has many examples of which one is the now-abolished practice of Chinese foot binding. This ancient custom, considered as the ultimate expression of feminine beauty and social status by a Chinese woman, was to have a tiny 'lotus' foot by tying the foot tightly in a way which, in time, would create a man-made artificial heel. Similarly the custom of wearing large circular lip plates by the Kichepo women in Sudan is yet another example of reshaping of the body. The women would consider themselves undressed without their lip plates and would never be seen in public without them. The Paduang tribe also known as Kayans, have a tradition of artificially elongating the necks of girls and women with a series of brass rings.



Fig 1.7 Woman with brass neck rings

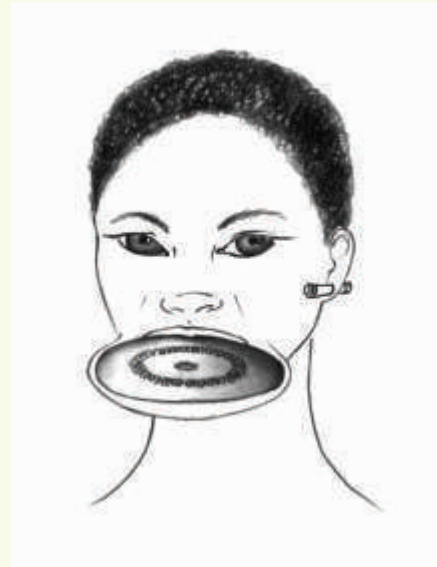
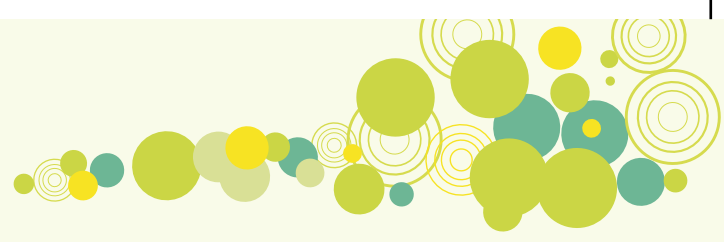

Fig 1.8 Woman with lip plates

- ❖ **Scarification** is an indication of status and tribal identification in some African cultures. Elaborate incisions in a delicate pattern are made in certain parts of a person's body. The painful incisions must be endured without any signs of physical distress or pain. Natural skin irritants are rubbed into the skin which, on healing, leave characteristic scars and raised pattern-like marks on the face and body that identify the individual as an adult member of the tribe.



Fig 1.9 Scarification



❖ **Body Tattooing** involves a permanent change in body colour based on the insertion of an indelible dye in the punctured skin. Tattooing was used by the Thracians to indicate rank. In some African societies women's foreheads were tattooed so that if captured by rivals, she could be sold back to her own tribe. Tattoos on men serve the same purpose as war uniforms by making them identifiable by their own tribe. The Maoris of New Zealand have elaborate facial tattoos as marks of distinction and esteem. Some Indian tribes also tattoo their body. In modern societies tattooing can be a form of personal adornment or can indicate ones affinity/allegiance to a group. The Japanese Yakuza have a tradition of tattooing which has symbolic meaning. In a western society, tattooing is commonly seen among sailors, biker groups etc. Today tattooing is fairly common among the youth across the world.

❖ **Body Painting** which includes face painting has its roots in sacred ritual. Girls in some Congolese tribes oil themselves all over and dust on red powered camwood in order to look more attractive. Noble ladies of some ancient Chinese dynasties as well as Japanese 'geisha' girls applied very heavy face make-up with the powder of ground rice and white lead. Application of rose petal rouge on cheeks and centre of the lower lip, simulated a tiny-pursued mouth, considered to be very beautiful. The modern cosmetic industry thrives and flourishes due to the interest of women for 'painting' their faces.



(iv) Identification

Clothes are the most visible index of the status of a person identifying the class, caste and profession.

1. Identification of social status

In most societies, people influence advertise their position and wealth through outer trappings like the choice of clothes, colour and fabric consumption. Based on the same line of reasoning, in some civilization complete nudity was considered a lowly condition, bereft of status. Therefore slaves could be nude since they were 'non-persons'. In pre-Inca Peru, the Mochia stripped their prisoners of clothing and therefore of rank and humanity.





At different points of time in history, rulers have attempted to maintain the status quo between themselves and commoners through restrictive sumptuary laws. Medieval laws restricted the use of fabrics like velvet, laces and fur while some colors like purple and gold were reserved exclusively for royalty and nobility. In 17th century England even the length and elaborate styles of clothes and accessories were regulated.

2. Identification of Rank

Clothes also clearly indicate rank and power as in the case of uniforms of the armed services also used to:

- + Intimidate or evoke obedience.
- + Encourage a sense of allegiance, loyalty and identity within the ranks
- + Emit clear signals indicating hierarchy through the design and number of buttons, insignia and ribbons

3. Identification of Profession

In contemporary times professional and administrative costumes distinguish the wearer and imbue him/her with personal or delegated authority. Examples of this can be seen in the robes and wigs of a judge or in the uniform of army personnel or policemen. On the other extreme end of the spectrum, are the clothes of convicts.

4. Identification of marital status

Dress and ornament are also indicating of the social and marital status of women. Among the Yoruk Turkis nomads, a girl can border her silk head cloth with coins to signal that she is ready for marriage. When betrothed she also wears a white scarf along with the headdress. If a widow wishes to remarry, she braids her hair under her black scarf. In parts of India, the vermillion or crimson *Sindoor* powder applied in the parting of the hair and the *Mangalsutra* necklace are symbols of the married status of women. In Western culture, a wedding band on the ring finger indicates marital status.

5. Identification of individual status in a tribe

Costumes also help to identify to special individuals by imposing authority and instilling a sense of fear and awe in others. For a tribal chieftain, certain components of the costume single him out of the crowd by expressing his power and special status. Similarly, a warrior's costume emphasizes his physical superiority. A tribal shaman wears special clothes, mask and carries accessories which single him out as a person 'apparently' endowed with supernatural power to cure or expel evil.



Exercise – 1

Fill in the blanks

1. Much of our knowledge about prehistoric textiles used in surviving specimens comes from _____.
2. The belief that parts of animals like claws, hooves and teeth would enhance the wearer's strength and imbue the characteristics of that creature stems from the _____ factor affecting clothing.
3. Clothes are the most visible index of the _____ of a person identifying the class, caste and profession.
4. The four factors affecting clothing are protection, rituals, adornment and _____.
5. Beautification of the self has been the pre-occupation of humans and is achieved through clothes and body _____.
6. In 14th century Europe, the exaggerated length of men's shoes called _____ was indicative of their socio-economic status.
7. _____ involves elaborate incisions in a delicate pattern on the skin which on healing, leave characteristic scars and raised pattern-like marks.
8. Historically, rulers have attempted to maintain the status quo between themselves and commoners through _____ laws.
9. Uniforms of security personnel and robes of judge are indicators of _____.
10. In parts of India, the coloured powder put in the hair parting called _____ is a visual indicator of married status of women.

Review questions

1. What are the views regarding the origin and need for clothing?
2. According to fashion historian James Laver, what are the three principles which govern clothing?
3. Name the material used by primitive man to cover the body.
4. The need for clothing was borne out of physical necessity. Explain this statement in the context of clothing or Eskimos and people in Saudi Arabia.
5. What is the difference between fashion and costume?
6. Name the factors affecting clothing?
7. What are the types of body adornment?

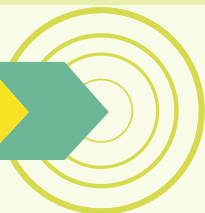



8. History has examples where exaggerated styles of clothing or accessories sometimes overpower comfort in clothing? Discuss this statement with reference to the poullaine.
9. How does body adornment visually indicate the status of a person in society?
10. What does the term 'scarification' refer to:
 - i) Body-incision in delicate pattern
 - ii) Permanent change in body colour
 - iii) Rubbing rice powder in a wound
11. In what ways are clothes the most visible index of the status of a person?

Activity – 1

Background: Clothes are the most visible index of the status of a person identifying the individual, social or marital status, rank, identity, caste and profession.

This activity is intended to encourage students to focus on uniforms as visual indicators of rank and profession.

1. Identify the professions where uniforms are mandatory.
2. Refer to books, magazines or internet for historical or contemporary personalities whose photographs always show them in uniform.
3. Discuss the possible reasons for their style of dressing. Is there a commonality in their profession?

1.2. Origin and Development of Costume

Today, clothes appear in a bewildering array of permutations and combinations ranging from inners to outers, uppers to lowers, co-ordinates to co-wear ensembles. At different points of time in history, costumes with different cuts, silhouettes, colours and fabrics in various combinations, developed in different parts of the world. Some costumes were integral to civilian life, while others were designed to meet the specific functional requirements of the large scale of successive wars. It was only with time that elements of one genre of clothing permeated into another.

Over several thousand years of history, all clothes can be broadly classified under 5 archetypes or categories.

- + **Draped Costume** derived by the wrapping of skin or material length around the body like the Egyptian *schenti*, Greek *himation* and the Tahitian *pareo*.

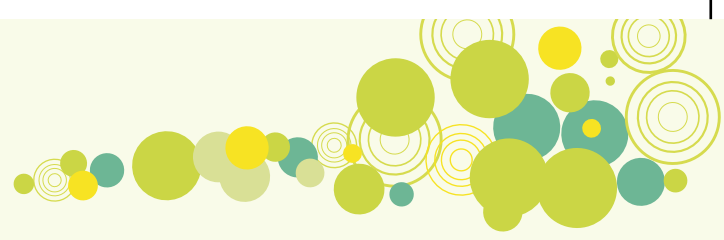

- + **Slip-on costume** made from one piece of skin or material length, with a hole for the head to pass through. Examples of this would be the Roman paenula, the Medieval huque and the South American poncho.
- + **Closed stitched costume** where the fabric is worn around the body with armholes for the sleeves to be attached. This category developed into the Greek *chiton*, the Roman tunic, the Medieval *chemise*.
- + **Open stitched costume**, worn over layers of inner clothes. Examples of these are the Asian caftan and the European overcoat.
- + **Sheath costume** fitted/moulded to the body contours. This category also extended into trousers and breeches.

Draped Costumes

Draping is the simplest response to wearing clothes since it has the inherent flexibility of swathing the wearer in an individual manner. Both in Western and Asian civilization, draped clothes have preceded cut and sewn fitted garments.

1.2.1 Indian Costumes

By and large, ancient Indian garments were draped rather than stitched, giving each ensemble a distinctive look. Draped apparel was worn both by men and women. Indian ceremonies from birth, marriage to death involve the ritual use of newly woven textiles draped around the body. The *saris* and *dhotis* worn today are similar to the off-the-loom fabrics worn thousands of years ago.

The earliest references to textile production and draped garments in India, date between 2500 to 2000 BC in the Indus Valley civilization in the two cities of Mohenjo Daro and Harappa. Our knowledge of early Indian costume is based on the study of sculpted figures and engraved seals, where both men and women are depicted wearing unstitched fabrics draped around the body. The statuette of the 'high priest' wears a patterned shawl with a formal drape. Other statuettes and engravings are seen in short draped sarong-like skirts, jewellery and elaborate hairstyles. Similar garments can also be seen in the later Ajanta cave paintings where the figures are scantily dressed with a tight sarong around the waist accentuating the curvaceous forms and a thin draped shawl or *choli* on the upper body. The unstitched garment is no less sophisticated than the sewn garment.

While traditional Indian garments were unisex, the fabric and the manner of draping, were indicative of the profession and social status of the wearer. These were primarily of three categories:

- + *Uttariya* or upper garment

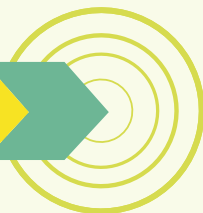



- + *Antariya* or lower garment
- + *Kayabandh* or sash

The **Uttariya** or upper garment was usually of cotton or silk with ornamented borders and fringes. The way it was worn depended on the profession of the wearer. In court, the *uttariya* could be draped on one or both shoulders, diagonally across the chest. It could also be loosely draped across the back with the free ends hanging down both the lower arms or wrapped around the wrist. For practical purposes, the working classes wrapped the coarse cotton *uttariya* around the head for protection against the sun or wrapped it snugly around the waist, leaving the arms bare. Women wore it as a head covering, hanging straight down the back or secured with a headband. This could also be held in place by wearing tight fitted caps under or over it.

The **Antariya** of white cotton, linen or muslin was the main garment for both sexes. Occasionally it could be embroidered in gold and embellished with precious stones. The *antariya* worn by women was initially of opaque fabric and later of transparent material. A small piece was fixed to the sash in front, passed through the legs and tucked at the centre back. It could also be worn as skirt wrapped around the hips.

A sash called **Kayabandh** was fastened at the waist, knotted at the front. The manner or tying and decorating the sash could be either simple or elaborate.

Men wore unstitched pieces of fabric draped on the hips and passed between the legs like a loincloth called **Kachcha**. While commoners and peasants wore a shorter version, the length of this garment varied from waist to the calf or ankles for the higher classes.

The **Ushnisha** was a turban for men. Along with the hair, it was twisted into a top knot and the rest was wound around the head.

It should be noted that trade and invasions have always resulted in cross-cultural influences in clothing. For example in the Kushan period, due to trade with Greece, *antariyas* developed stiff, pointed fluting associated with the Greek *Chiton*. Kushan costume for women showed the change and evolution of draped garments similar to Greco-Roman costume. For example the Greek '*palla*' which was the draped overgarment was worn over a long gown with ruched (gathered) sleeves, pinned on the left shoulder.

Unchanging in its essence, is the traditional six to nine yard sari, where the manner of draping is indicative of the geographical location in India where the wearer resides. There are several traditional sari drapes in India. The draped unstitched garment has a wide border on one end called *palla* with the rest of garment with narrow or wide borders either woven or sewn to the fabric. Variations in the drape are sometimes simple like wearing the *palla* over the left shoulder hanging down the back or worn in the traditional



Gujarati or Marwari style with the *palla* brought over the right shoulder to fan out in front. At times the fabric is pleated in the legs and tucked at the back the waist. The free end of the *palla* is sometimes used to cover the head like a veil.

1.2.2 Ancient Near East

Between 3500 - 3000 BC, a great civilization arose in Mesopotamia, now in present day Iraq. Some of the different cultures of the Sumerians, Babylonians and Assyrians who inhabited Mesopotamia, all showed a strong commonality in their draped clothes.

i) Sumerian Costume

The most basic form for both men and women was the simple ankle-length, wrap-around skirt. The sculpture of a priest shows him in a long **kaunakes** skirt tied at the waist, while the excess waistband forms an animal-like tail hanging loosely at the back.



Fig 1.11 Ebikil, superintendent of the Ishtar temple at Mari, Paris, Louvre

ii) Babylonian costume

The earlier, thicker, tufted kaunakes skirt was transformed into a draped look worn by both sexes. Those of high rank wore elaborately draped large woven shawls edged with fringes and tassels while lower ranks wore simple linen skirts. A typical style was of the shawl draped under the armpits across the body with the excess fabric covering the left arm and thrown over the left shoulder leaving the right shoulder and arm bare. The style almost prefigures the Greek Himation or Roman Toga two thousand years later.



Fig 1.12. Elamite woman in draped Babylonian garment secured with a pin on the left shoulder, reminiscent of the Indian sari.





iii) Assyrian costume

The Assyrians wore either rectangular or semi-circular draped shawls with the short-sleeve tunic. Another small square or rectangular shawl was worn like an apron at the back, while the semi-circular shawl was draped around the torso. The amount of fringe edging also indicated rank.



Fig 1.13. Drawing of Assyrian king wearing draped tasseled shawls over a belted tunic

1.2.3 Egyptian Costume

A characteristic of Egyptian costume was that it covered the lower body, leaving parts of the upper body bare. Egyptian clothing was mainly draped and pleated. The basic garment for men was the **schenti** which was a single strip of linen wrapped around the hips, worn by all classes, except for the fact that the Pharaoh's schenti was much finer and often pleated. Similar to the Indian drape, the common way of wearing it was diagonally across the hips with one end tucked in at the waist and the other hanging free in front. Male royalty also draped a large transparent material around the body knotted at the waist creating elaborate folds at the hips called the **haik**. Women wore the sheath-like tunic called **kalasaires**.

Religious costume was an important part of Egyptian clothing. When the shawl was not draped but merely placed flat on the shoulder, it became a ritual garment which covered the arms but left the hands bare.



Fig 1.14. Seti I and the Goddess Hathor, painted relief 19th dynasty, Paris, Louvre



The Pharaoh wears the Schenti under the draped transparent material around the body creating elaborate folds at the shoulders and hips of the royal 'haik'. The Queen wears the Kalasaires

1.2.4 Greek Costume

Ancient Greek and Roman costumes were draped in a traditional manner. Draped styles of dress were characterized by the arrangement of large pieces of rectangular, oval or crescent-shaped fabric which were folded, pleated, pinned or belted around the body in different ways. This style of dressing utilized the entire fabric ensuring there was no waste. In spite of influences from other countries, Greek costumes did not undergo any major transformation.

Classical Greek costumes were based on two principles:

- + The first was that a unisex rectangular piece of cloth woven in varying sizes was the basis of all draped styles, be it a tunic or a cloak.
- + The second was that this cloth was always draped around the body according to certain norms, but not cut or shaped. There were vast possibilities of drapes that could arise out of this rectangular fabric, as seen in the examples of architectural draping at different temples.

Greek costume for men

The basic costume was the Chiton, a rectangle of cloth usually wool. It formed a tunic fastened on the left shoulder leaving the right arm free or on both shoulders. This could be worn with one or two belts at the waist. Without a belt this tunic hung loosely and served as a night garment. When lengthened, it became a ceremonial or festive costume. It could also be draped around the body like the Indian shawl.

Another male garment was the enveloping cloak called Himation made of a single large (6' x 9') piece of cloth, swathed around the body without fixed fastenings. This cloak was versatile in its draped style:

- + It could be worn alone, baring the right arm, shoulder and upper chest.
- + It could also wrap the wearer up to the chin covering the arms and the head.
- + It could be used as a blanket at night.

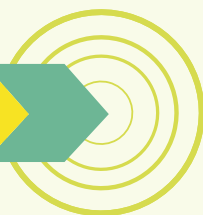

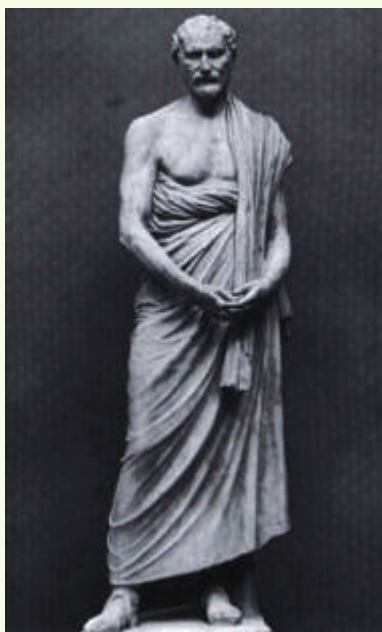

Fig 1.15. Statue of Demosthenes in draped Himation, Copenhagen, Ny Carlsberg Glyptothek (Museum photo)



Fig 1.16. Statue of Dancing girl in Doric Peplos, Naples, Museo Nazionale

Greek costume for women

All Greek women wore the **Peplos** which was essentially a rectangular shawl with a fibula or brooch/ decorative pin on the shoulder and was usually open on one side. This open peplos was usually not belted at the waist. Greek women also wore the closed peplos by seaming the two free edges of the fabric together.

1.2.5 Roman Costume

Roman costume was more class-based than that of the Greeks and reflected the society's formal distinctions between its own citizens and outsiders, within a highly organized system of rules. The civilian costumes of the Romans were broadly classified into two categories:

- + Those which were slipped over the head
- + Those which were wound around the body.

The wrapped garment was a Roman cloak called **toga**. Originally it was an outer garment for both sexes which also served as a blanket at night. The draped cloak was made of a large piece of cloth cut as a segment of a circle. Gradually the toga became extremely wide and complicated especially when used as a ceremonial garment. The elite indicated social status through various interesting ways of slanting or crossed drapery to which bands of specific colours were added for distinction.



Women wore a tunic with the draped **palla** which was the equivalent to the male toga. It was a large square or rectangular piece of cloth folded lengthwise and held on each shoulder with the fibula. It could partly cover the head and partly mask the face.



Fig 1.17. Roman men wore draped Toga with the band along the edge of the fabric

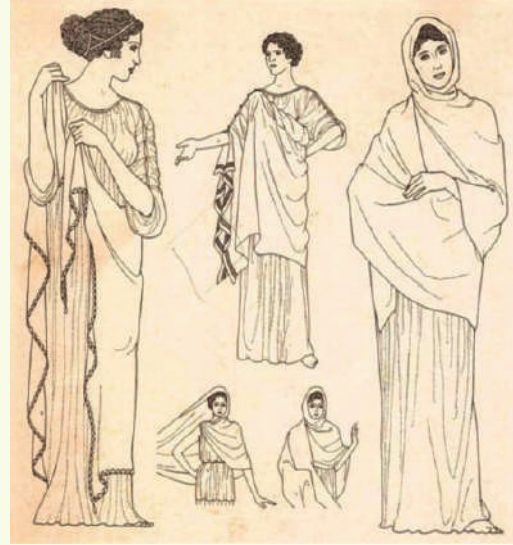
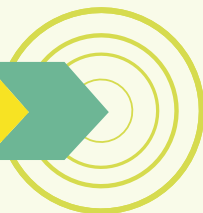

Fig 1.18. Women wore the draped Palla

Exercise – 2: Match the Columns

1	Fastening/pin to hold the ends of the Greek peplos together	Antariya
2	Egyptians unisex garment	Chiton
3	Only free Romans permitted to wear this garment which could be draped in various ways to indicate social status	Schenti
4	Sumerians skirt with an excess tail-like waistband	Kaunakes
5	Roman counterpart of the Greek Palla	Himation
6	Detail which indicated rank among Assyrians and Babylonians	Fibula
7	Upper garment worn by ancient Indians	Fringe
8	Garment worn by Egyptian men across all social strata	Toga
9	The Greeks wore this versatile garment like a tunic which could be belted, lengthened or draped like a cloak or shawl.	Kalasaies
10	Indian draped lower garment	Uttariya





Review questions

1. State the 5 broad archetypes of clothing?
2. Give two examples of draped and slip-on costumes.
3. What were the broad categories of Indian garments?
4. What was the difference in the way the basic Egyptian garment was worn by the King and commoners?
5. How did the Roman men indicate status through clothing?
6. Explain the term Uttariya. Briefly explain the manner of draping among the different classes of society.
7. Elaborate on the following terms:
 - i) Kaunakes
 - ii) Schenti

Activity – 2

Background: Both in Western and Asian civilization, draped apparel have preceded cut and sewn fitted garments giving each ensemble a distinctive look worn both by men and women. The manner of draping the traditional six to nine yard sari is indicative of the geographical location in India where the wear resides. There are several traditional sari drapes in India. This activity is intended to provide students with hands-on practice of recreating drapes of ancient Indian garments. Student shall work in parts to perform this activity.

1. Refer to books, magazines or internet and collect pictures of different sari drapes.
2. Are there commonalities and differences in the drape according to the geographical region? Are the saris of the same length? Has the manner of draping the sari changed or remained unchanged over the year?
3. Select any one ancient draped garment from the chapter (sari antariya, uttariya)
4. Refer to books from the Bibliography to find out more about the way the garment was draped.
5. Demonstrate the draping process step-by-step in class

1.3. War Costumes And Uniforms

The history of mankind has been synonymous with warfare, which necessitated the use of clothing and accessories specifically for war. War costumes evolved naturally from the geographical location and the terrain. The use of locally-available indigenous material and the specific techniques of warfare, necessitated the shape, construction and colour of the battle-gear/armour/uniforms that visually distinguished each battalion or army. The crucial requirement of armour was to protect the wearer.

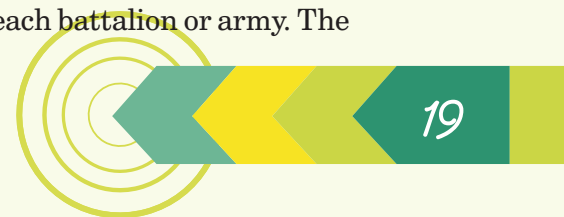



With a change in the techniques of warfare, armours were replaced with uniforms. Uniforms are composed of a specified set of clothing choices with detailed specifications on their combination. This has enabled the following:

- ✦ Instantaneous identification of one regiment from another and one's own army from that of the enemy.
- ✦ Created a means to instill loyalty and a sense of common purpose among soldiers.

Uniforms are worn by not only by the armed forces but also by members of a specific group (e.g. schoolchildren, scouts, cheerleaders), profession (e.g. soldiers, nurses, chefs) indicative of hierarchy (e.g. jawaan, Lieutenant, Major, General). Uniforms exert a strong influence on civilian modes of dressing. Their appearance, details as well as construction have often inspired designer collections.

An overview of war costumes and uniforms with examples is given below:

1.3.1 Armour

The armour is central to all forms of traditional battle uniforms and is mentioned in historical references of different countries. Several museums across the world have a section on protective battle gear and weapons. The appearance of armour symbolizes strength, power and impregnability. Since the warrior's chest was the target of impact for the enemy's weapons, the armour was constructed in way to reduce the vulnerability of the wearer. Armour for the soldier and his mount (horse, elephant) was enhanced in tandem with improvement in weapons and tactics. It was most important that it had to offer protection yet be light and flexible enabling maximum freedom while fighting, twisting, running, riding etc. The type of armour varied between Western and Asian countries.

(i) Techniques of Armour Construction

In several civilizations over the ages across the world, metallic armour was traditionally used. Irrespective of the differences in design and type of construction, the armour was not a single piece but included separate pieces for protection of different parts of the head and body.

A broad classification of the different ways of constructing armour is as follows:

- Scale armour** where small scale-like overlapping metal pieces were fixed to the foundation garment of leather or fabric. The plates had small holes so that they could be laced to the foundation with wires without any gaps. The problem of this armour was its inflexibility and stiffness since the plates could not move.
- Lamellar armour** consisting of many small narrow overlapping pieces (Lamellae) joined to each other with laces made of metal or rawhide.





- c) **Mail armour** where iron or steel rings form a mesh-like interlocking curtain. It has been the most widely used by Romans, Persians and Indians. While it protects the wearer from sword blows, it is extremely heavy and cumbersome.
- d) **Plate armour** used a riveting technique to loosely link large metal plates and by leather on the inside that allows articulated sliding movement and also offers very good protection from sharp spears and other instruments.
- e) **Mail and plate armour** combine the best of both types. Large metal plates are loosely linked by mail that offers protection and flexibility with additional advantage of being light.
- f) **Leather and fabric armour** of varying thicknesses were the oldest forms made of multi-layers of leather or fabric quilted together. They also reduced the chaffing of skin. These were usually worn by ordinary soldiers. However the protection in war was relatively ineffective as compared to the armour made partly or completely in metal.
- g) **Brigandine armour** was made of small metal plates riveted to a rigid inner lining of the garment at vulnerable points.

(ii) **Armour Accessories**

Generally body armour was worn with other items like helmets, legwear and gauntlets.

❁ **Helmets**

The purpose of the helmet was to protect the most vulnerable parts of the warrior namely the head and face. According to rank, it was designed to intimidate the opponent by its impressive structure, height and splendour. The components were:

- ❖ *Helmet* (covering the crown of the skull) including the spike, plume holder
- ❖ *Faceguard* including the cheek guard, nose guard - either fixed or movable
- ❖ *Neck piece* including the neck flange at the nape
- ❖ *Mail curtain* or *Aventail*

The faceguard necessitated that the wearer should be able to breathe, see and speak clearly.

❁ **Leg Armour**

Military footwear needed to be both protective and visually distinctive. The medieval knights wore metalsabaton (shoes) and greaves (shin armour).

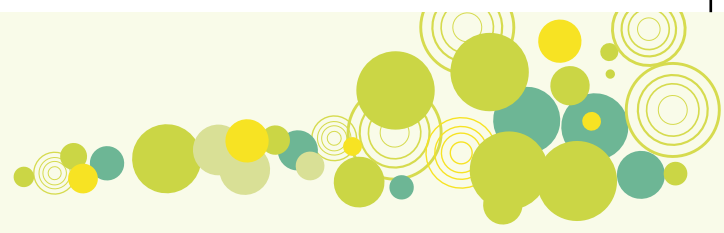

Fig 1.19 Gladiator helmet decorated with Gorgon masks. From Herculaneum, Paris, Louvre

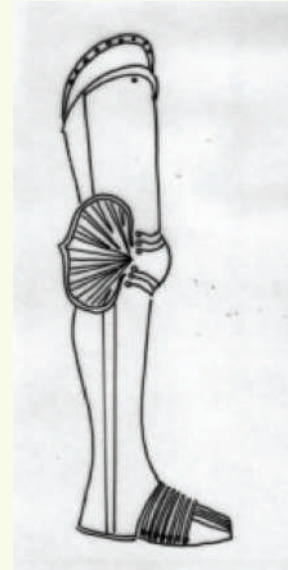

Fig 1.20 Shin greaves

1.3.2 Ancient War Costumes

- (i) The earliest examples of clothing worn by warriors are found in **Sumerian** culture. The soldiers wore a long fringed skirtover which a wide band of nailed leather re-enforced with metal studs for protecting the back and chest was thrown over the left shoulder and hanging down the back. They also wore rawhide caps and copper helmets sometimes fitted with chin straps and padded with wool and leather.



Fig 1.21 Mosaic inlay from Mari, Paris, Louvre

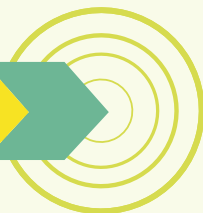



- (ii) Like the civilian population, the **Egyptian** soldiers wore the white schenti while troops of tributary nations could wear coloured or striped versions. It was layered with a leather apron and a belt of coloured cloth or leather. The head was protected by a padded wig or a war-cap of thick cloth. Officers wore a *Kalasaïres* with torso armour of leather or linen. The light armour was suitable for the climate but not very effective in terms of protection.

- (iii) **Greek** soldiers wore a short draped woolen cloak called *chlamys* (Fig 1.22) made of a strong, tightly-woven yarn fastened on the shoulder or back to cover both shoulders. During warfare it could be wound around the left arm to deflect blows. The Greek cavalry wore a leather jerkin strengthened with bronze disks, shoulder pieces and leather leggings. The infantry wore the chest armour called *cuirasse* (Fig 1.23) made of sewn or riveted metal scales re-enforced on the shoulders and chest over the padded tunic. The helmet with a round crown, nose and cheek guards was made of shaped metal plates.

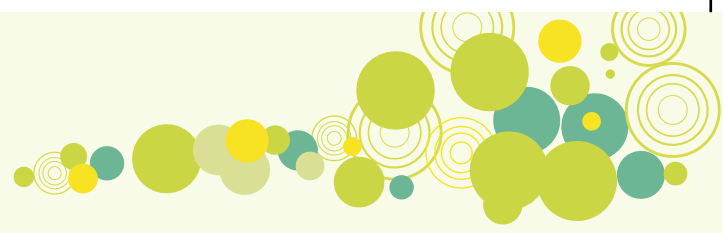

Fig 1.22 Cup, Paris, Louvre



Fig 1.23 Funerary stele, Athens, National Museum

- (iv) The **Roman** legionary and infantrymen wore the padded inner tunic with reinforced chest under the coat of mail under the *cuirasse* to protect the wearer from burning hot or icy cold metal. It consisted of overlapping plates of metal riveted to leather straps which covered the chest, shoulders and waist.



The *cuirasse* of the Emperor or those of higher rank was made of embossed metal plates depicting battle scenes with leather tabs trimmed with metal over the shoulders and abdomen.

Roman accessories consisted of a broad belt of leather to which a leather apron could be attached. They also wore sturdy boots with thick soles and several crisscrossing leather thongs with shin greaves. The helmet originally of bronze and later of iron, had a smooth crown with a plume of feathers, neck flange, cheek guards and a fixed visor with a slit for the eyes. The gloves/gauntlets were lined with cloth or leather.



Fig 1.24 Emperor Trajan, 2nd century, Paris, Louvre.

- (v) In the **Medieval** times a warrior wore a quilted doublet under the coat of mail. During tournaments, the knight wore a civilian tunic, over which he wore a leather jerkin with a slit at the back to facilitate mounting and dismounting of horses. For the purpose of identification and decoration, he wore a sleeveless or short-sleeved *surcoat* and carried a shield with visually distinctive emblems with mythical creatures (e.g. dragon or unicorn) or majestic creatures (e.g. lion or eagle).

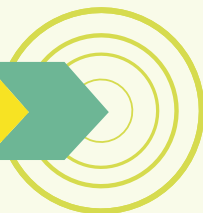



Fig 1.25 Medieval knight in armour

1.3.3 ORIENTAL AND INDIAN WAR COSTUMES

(i) Japanese war costume

The Samurai armour indicates the prestigious status of the warrior class of the feudal Japan. Early Samurai armour and helmets developed in complexity over the centuries. To facilitate free and rapid movement of the sword and for protection against the opponent, Japanese armour consisted of several lacquered metal plates, laced tightly with coloured silk, helmets, breast plate, belts, wraps, detachable shoulder plates, arm plates, thigh plates to create a variety of styles until the whole body was protected.

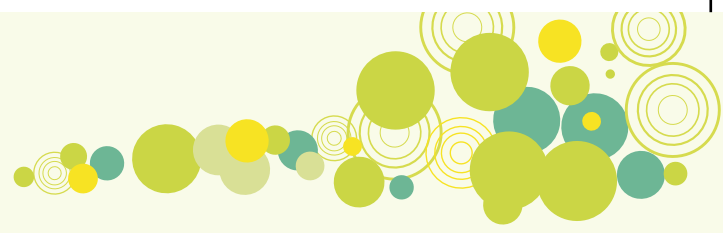

Fig 1.26 Japanese armour

(ii) Indian war costume

In India, evidence of armour of different materials from early periods is found.

- + In the **Vedic period** (1500 BC) the covered his shoulders with a *varman* made of metal wires along with a layered headgear. The left arm was protected by a leather strap from the string of the bow.



- + In the **Kushan** period the soldiers wore a *mauli* (turban) made of a twisted roll of cloth, long-sleeved tunics with the *antariya* worn either in the *kachcha* style with the fluted end tucked in at the centre front or in a *lehenga* style. The skirt segment of the armour was made of rectangular scales with the hem reinforced with cording or some other form of edging. The chain or scale armour of geometric shapes was fastened with strings like Japanese armour.
- + The military uniform of the **Gupta** kings consisted of a shorter *antariya* with a *kayabandh* that was wound tightly around the waist. A protective chest piece with criss-crossing bands held with a buckle, gave way to the sleeved, knee-length tunic called *kanchuka*. Extra protection was provided by the metal breastplate called *urastrana* which was a single plate from neck to waist.
- + The **Rajput** kings also wore a 'coat of mail' made of metal links which allowed flexibility in movement. Though it was strong enough to resist sword blows, in order to deflect or minimize a blow, it was worn with metal breastplates.

The *chilta hazaar masha*, (coat of a thousand nails) was strengthened with studs on fabric reinforced with plate armour, elaborately studded with small gilt-headed rivets.

- + The **Mughal** amour called *zirah bakhtar* was a chain mail shirt worn over a quilted inner garment. It had full sleeves with a skirt divided at the fork till the calves. Over this armour, an *Angrakha* or long fabric coat was worn. The *kavach* was a waistcoat of armour where the back plate and front were hinged at the shoulder and pinned on the sides. The armour was gilded in gold and the insides were padded for comfort. The trouser legs were also partly covered in mail. On the feet were heavy leather *jootis* further reinforced by studs or metal plates.
- + The **Indo-Persian** *char-aina* meaning four mirrors, included a coat of mail over which four plates were attached. The chest and back plates were larger while the side pieces were narrower, smaller and shaped to fit under the armpits. They were attached to each other by leather laces and hung from the shoulder with straps usually worn over a mail shirt or directly attached to the mail. There were delicate engravings on the plates.



Fig 1.27 Chilta Hazaar Masha





Armour Accessories

+ Arm armour

The arm guards or *Bajubandh* were worn for protecting the arm, usually with a glove/ gauntlet. Today the word refers to an item of jewellery worn on the upper arm.

+ Helmets

Helmets had decorative elements like dome-shaped fittings, a plume holder, movable nasal guard and/or a *camail* (chain mail) to protect the neck at the back and sides. Today helmets are a mandatory requirement for road safety of motorcycle and car drivers.

1.3.4 Uniforms During World Wars

Significant differences emerged in the war uniforms before World War I and those after it.

- + At the outbreak of World War I armies wore utilitarian, neutral-coloured outfits.
- + The **English** aviators of the Royal Flying Corps wore fleece-lined leather flying coats with long boots and gauntlets under which was a double-breasted tunic with concealed buttons to keep warm in open cockpits. Goggles, masks and helmets protected the face and eyes.
- + The characteristic grey uniform adopted by the **Germans** was teamed with a steel helmet. During World War II the German army consisted of both the army and the special security combat division called Waffen SS. While the traditional features and insignia like the gold collar patches were retained, Hitler brought in a new National symbol of an eagle clutching an oak leaf encircling the 'swastika'. Piped edges of red, white and carmine distinguished the uniforms of different divisions of the army. The SS unit had its own unique rank and unit markings.

(i) Influence of War Uniforms on Civilian Clothing

Uniforms exert a strong influence on civilian modes of dressing. The World War uniforms have influenced 20th century clothing in different ways:

- + *Items of clothing:* Examples include peaked caps, leather 'bomber' jackets, high leather boots, brass-buttoned double-breasted overcoats, jodhpur trousers etc. The precision of cuts and silhouettes have been modified in men's formal tailored clothes. Since the World Wars, the incorporation of uniforms into civilian clothing



has created practical clothes for formal occasions like tailored clothing (jackets, suits), security personnel uniforms, semi-formal (safari suits) leisure wear etc. The Sailor suit consisting of a short blouse with a large V-shaped collar at the front and low square flap at the back and dark-coloured necktie, is often seen in children's clothing and also nautical-theme collections.

- + *Details of insignia:* This includes symbols like stars, stripes, braids, national emblems etc. These may be stitched/ appliquéd, embroidered, braided in fabric or metal and attached to the collar, epaulet, sleeve or shirt front.
- + *Colour:* From the late 19th century a dust-coloured lightweight cotton drill fabric called **khaki** was used by the Indian army during the British Raj. The word *Khakhi* is related to the military be it in terms of colour (olive green, brown), fabric (hard-wearing cotton), details (collars, shoulder epaulettes, outside pockets) or garment (colonial or jungle- oriented). Originating from the word '*khakh*' (meaning dust/ earth/ ashes), the colour was derived from a variety of substances used for dyeing like tea leaves, ground coffee beans or inks creating shades of brown, grey and off-white. *Khakhi*-coloured uniforms reduced visibility of the soldiers and downplayed dirt marks more effectively. Today it is a colour synonymous with uniforms of law-enforcement services in India like the police.
- + *Prints:* Today different kinds of camouflage prints (also referred to as 'disruptive patterns') are used by the military across the world. Specific patterns in varying colour combinations (like brown, beige, green, blue, grey) blend in the dense vegetation, mountainous regions or deserts. These are designed so as to conceal the soldier's presence thus making him inconspicuous as a target. Today camouflage prints in clothing and accessories (boots, headwear etc) are a part of the uniform of both army and para-military forces in several countries.

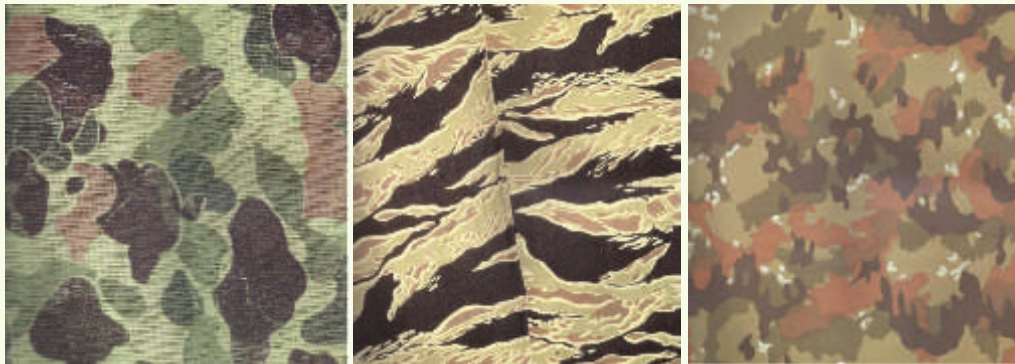

Fig 1.28 Camouflage prints

Even in recent times their surface design, design details as well as construction techniques continue to inspire designer collections.

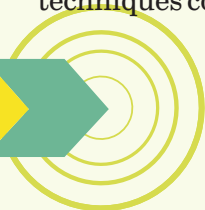
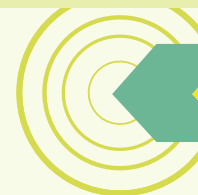



Fig 1.29 Ritu Beri 2010

Exercise – 3 : Fill in the blanks

1. The Gupta soldiers wore the metal-plated _____ to protect the chest.
2. The Rajput armour studded with nails was called _____.
3. The Mughals wore a waistcoat of armour with hinged front and back plates called _____.
4. The Mughal amour called _____ was a chain mail shirt worn over a quilted inner garment.
5. Generally body armour was worn with three other items namely helmets, leg guards and _____.
6. The arm armour called _____ was a part of the Indian armour ensemble but has now become a jewelry item.
7. _____ as a word indicates both a colour and a garment.
8. The Greeks and Romans wore chest armour called _____.
9. _____ prints are designed to blend in the surrounding terrain.
10. Protection of the torso from bruising caused by wearing armour, necessitated _____ technique, which led to the development of jackets.





Review Questions

1. What is khaki?
2. Why do military uniforms have camouflage prints?
3. Explain the term Armour? Discuss the different types of armour construction.

Activity – 3

Background: Period movies can be a source of costume history of different civilizations and ages. Award-winning movies like Ben Hur, Cleopatra, Gladiator, Troy, Mughal e Azam, Mangal Pandey, Jodha Akbar, Gandhi and others provide interesting visual references to civilian and war clothing.

This activity will enable students to relate textual information in this chapter with actual costumes in selected movies.

1. The teacher may select any movie which has won awards for Best Costume for viewing or discussion in class.
2. The movie may be viewed or discussed in class.
3. Costumes/uniforms/ armour and accessories in the movie may be correlated to the textual information in this chapter.
4. Do the costumes in the movie enhance the understanding of the civilization?

1.4 Industrial Revolution

Prior to industrialization of fabric production in the 18th and 19th centuries, the fabric cost was high which prohibited most people from possessing too many clothes. Most people had to spin their own yarns, weave and knit their own fabrics and then sew their own clothes in their spare time. Lower classes wore homespun clothes since fabrics in fine weaves were unaffordable for them.

In the mid-18th century, a general change swept Western civilization. The middle class grew stronger and began to actively participate in trade and industry. Every facet of life was affected including textiles and costume.

In England the Industrial Revolution rapidly transformed the country. Several new inventions followed by patents, considerably developed the industrial spinning and weaving centres. While these speeded up the process of textile

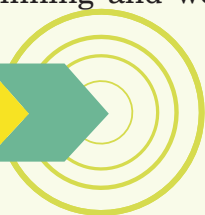



production, they also led to riots and laws were passed to stop their implementation due to the fear that increased mechanization could create widespread unemployment, thereby adversely affecting the lives of common people.

The opening of new markets in Spanish colonies, abundant imports of Indian cotton and extension of French silk mills also contributed to the change. The British textile industry primarily produced broadcloth. Manchester transformed itself from a market town to the centre of the cotton industry while Norwich produced wool and Coventry silk. The fall in prices, as a result of mechanization, opened up the world market for England.

Cotton revolutionized European clothing with the production of exclusive fabrics such as lawn and batiste. The vogue for cotton garments as well as accessories in lawn, muslin and gauze grew steadily. An unexpected effect of the use of cotton was the slave trade. Cotton cloth was transported to Africa where it was bartered for natives, who were then taken to the new American states. Subsequently, the ships returned with raw cotton.

1.4.1 Mechanical Inventions During Industrial Revolution

At the beginning of the 18th century, most of the work related to the textile spinning and weaving woolen industry was carried out in people's homes.

A chain of inventions changed the situation completely. This caused unrest among people who feared that machines which could do the work of several men would result in unemployment. Though sporadic attempts were made to break machines, the process of mechanization continued.

With the increased demand for cotton goods there was greater need for cleaning of cotton, which was normally an approximate amount of 1 pound in a day. **Eli Whitney** invented and patented an automatic Ginning machine which was a simple yet effective way of separating cottonseed from short staple cotton fibre.

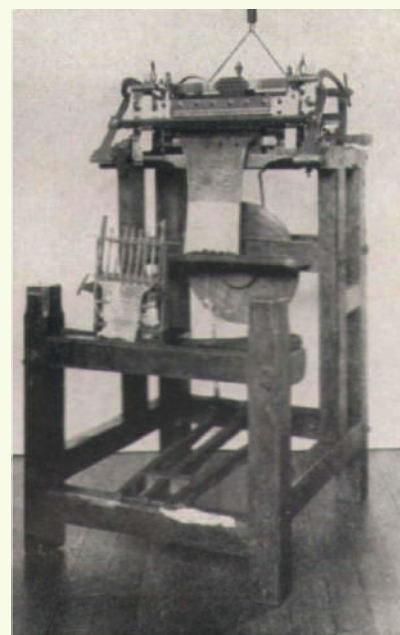

Fig 1.31 18th century knitting machine



In 1804 refinement and complexity in woven textile patterns came in the form of the Jacquard loom named after the designer **Joseph Jacquard**. This loom invented a way of automatically controlling the warp and weft threads on a silk loom by 'recording' patterns of holes on a string of cards. This relatively simple method evolved and was modified later into computer punch cards.

The invention of the sewing machine by was revolutionary. It inspired the first domestic sewing machine by **Issac Singer** in 1851. In the 19th century, the sewing machine brought the principle of assembly-line, which led eventually to mass production, standardization of sizes and ready-to-wear clothing, sold in departmental stores.

Increasingly, active scientific research made a lot of progress in colours and dyes. **Sir Isaac Newton** had earlier isolated the principal colours of the spectrum - red, yellow and blue of which the other tones were only mixtures. **Johan Tobias Mayer** explained the principles of colour mixing, obtaining several new shades. The new possibilities of colour provided textile manufacturers with numerous colour combinations. In 1856 **Sir William Perkin** invented the first synthetic dye.

1.4.2 Effect of Industrial Revolution on India

India was ceded to Britain by the Treaty of Paris in 1898. India's economy at this juncture as in ancient times depended largely on its textiles. Indian cotton and other specialized textiles were unmatched quality and were therefore used to trade in spices. During colonial rule, the traditional royal and temple patronage declined, as the British government changed India's role as the largest exporter of textiles in the world, to the biggest importer of English-made cloth. The country was systematically plagiarized as the Indian domestic market was swamped by cheap copies of Indian textiles, industrially produced in Lancashire. Stringent taxes were imposed on weavers who specialized in hand-made fabrics. As a result of this, weavers of textile weaving centres like Surat and Murshidabad faced tremendous hardship, to the extent that some textile weaving techniques became extinct.

British women's clothing profited from the progress made in the nation's mills whose raw material was provided by the East Indian colonies. Cotton was the most sought after for its superior quality, afford ability and durability. Beautiful

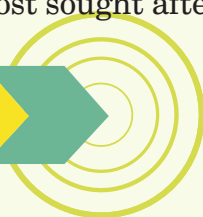



Indian prints called *chintz* (derived from the Indian *cheent* meaning 'spray of raindrops'), delicate muslins and calico fabrics were very popular in England. France too exhibited great interest in printed, painted or dyed calicoes called *Indiennes*. Shawls from Kashmir in complex designs and labour-intensive weaves called kani were regarded as luxuries in Europe. Inspired by the exotic garments of the West Indies and the exquisite clothes of the *nawabs* of India and Ceylon, British clothes were fashioned by overseas colonies. It is significant that words which are part of the modern global textile vocabulary like *chintz*, *muslin*, *calico*, *shawl*, *khakhi*, *kamarbandh*, *jodhpurs*, *pyjama* etc. are of Indian origin.

Exercise 4a: Match the following

Designed loom which could create complex weaves and developed later into computerized punch-cards	Eli Whitney
Invented the first synthetic dye	Isaac Singer
Invented the first domestic sewing machine	Johan Tobias Mayer
Obtained several colour shades which provided textile manufacturers with numerous colour combinations	Joseph Jacquard
Invented and patented an automatic Ginning machine for cotton	Sir William Perkin

Exercise 4b: Fill in the blanks

1. Indian peasants were forced to cultivate and dye cotton in indigo within an oppressive system called -----.
2. _____ was a popular Indian print with small flowers used in European clothing.
3. Cotton revolutionized European clothing and accessories with the production of exclusive fabrics like -----, ----- and -----.
4. Malmal is the Indian name for ----- fabric.
5. Stringent taxes imposed on weavers who specialized in hand-made fabrics resulted in some textile weaving techniques becoming _____.

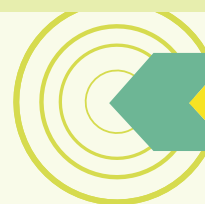



1.5 Effect of World Wars on Fashion

Though war and fashion seem unrelated, the influence of war actually affects lifestyle and, by extension, the outward appearance of people. The World Wars and the period between them brought about a socio-economic change with long-lasting consequences.

1.5.1. World War I (1914-1918)

During the war, the absence of men forced women to take on new roles and responsibilities. Traditional roles of governess and typist changed. Replacing social events in favour of nursing, women wore working uniforms of blouses, overalls or trousers with caps in ammunition factories. The serious mood of the nation and mourning for the dead, reduced people's interest in elegant dressing. From the economic point of view, decreased domestic production and currency restriction strengthened the trend. Several couturiers closed their business.

Elaborate fashion in terms of material, trims and ornamentation prevalent in the pre-war period gave way to new developments in clothing. Dark-coloured clothes were widespread.

The new role of women in society was affected by currency devaluation. Their role in society increased, replacing decorative styles with simplicity. The need for increased mobility and less fussiness led to skirts rising from above the ankle to the mid-calf. This also led to the adoption of silk stockings as a symbol of luxury and low-cut shoes instead of high boots. When the jobs became more regimented, the clothes became more uniform-like with a tailored look. The cut of men's costumes also remained constant with reduced details since they now led a more active life.



Fig 1.32 Womens clothing during World War





1.5.2 Between The Wars (1919-1939)

The upheavals caused by the war created a gap between previously prevalent traditions and new developments in society. Women's emancipation was strengthened by finally getting suffrage (right to vote) in 1920.

In the 'Roaring Twenties' decade, fashion saw the birth of casual wear for men and women. Swimming, travel and Jazz dancing changed the previous relatively sedentary lifestyle to an active one which toned the body, necessitating the shift from formal wear to sporty styles. Holidays now included travel to faraway places, there by making the right time to create separates like trousers, suits and wrap skirts. Sports like tennis ushered in white knit sports ensembles named '*Tennis Whites*'. Simultaneously there was also informality in men's clothing, emphasizing relaxation and youthfulness. Wool suits with softly tailored collars and slim silhouettes with padded shoulders became popular. As in the case of women, the widespread practice of sports saw the first '*Lacoste*' brand shirt in 1933.



Fig 1.33 Flapper girl in 1920s

Paul Poiret a *couturier* (designer of couture fashion), became a trendsetter when he refrained from designing tight corset dresses for women. Women's clothes were no longer restrictive in terms of length or ease; long dresses with trains, corsets and hourglass silhouettes were replaced by knee-length dresses with simple bodices and lowered waistlines. This style called the *Flapper Look* created by designer **Jean Patou** in 1925 had a slender, rectangular silhouette with delicate embroidery and accessorized with a long string of pearls.

The euphoria of the 1920s characterized by progress, abruptly changed with the Wall Street crash of 1929. As the stock market began to slide downward there was a corresponding lengthening of skirt lengths. As this economic disaster spread to Europe causing unemployment and inflation, expensive couture clothing became practically non-existent. Most women had no choice but to use their sewing



machines to make clothing that balanced style with afford ability. Even cotton was used for evening dresses. Cheaper mass-produced clothing and ready to use patterns for making designer wear duplicates, became popular in the 1930s. Tailored suits for women became a necessity.

At this juncture USA imposed a 90% tax on imported clothes. Dress materials and paper patterns being duty-free led to the development of reproductions based on simplified prototypes made in different styles and copied in affordable materials. American designers developed coordinated outfits which gave people the freedom to mix and match and thereby put together their own looks.

The period between the wars was dominated by 3 women designers: **Gabrielle 'Coco' Chanel, Madeline Vionnet and Elsa Schiaparelli.**

- + Vionnet produced exquisite dresses cut on 'bias' grain (45 degree grain) which curved and clung to the body. She is acknowledged as the creator of the 'cowl neck' and 'halter neck'.
- + Chanel's designs for the new woman were born out of her immense practical sense. She designed the blazer, boxy suits with chains, created her symbolic intertwined 'Cs' logo and popularized affordable costume jewellery.
- + Schiaparelli had an artistic approach to design using unpredictable whimsical motifs like lobsters, skulls, keys as well as humorous accessories and trims. Influenced by the Surrealism movement at the time, her clothes often made playful use of optical illusion which made her a designer imitated for many successive decades by others.



Fig 1.34 Design by Madeline Vionnet



Fig 1.35 Coco Chanel



Fig 1.36 Design by Elsa Schiaparelli

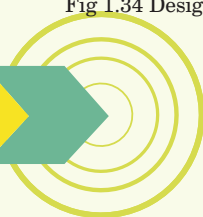



1.5.3 World War II (1939-1945)

The war once again affected the clothing industry as it did all other facets of life. For a while it seemed to severely restrict couture, the capital of which was Paris. Germany seriously planned to transfer French couture to Berlin and Vienna, neither of which had a tradition of fashion. In order to allow Parisian couture to retain its autonomy, designers launched a strong counter-offensive.

With the Parisian fashion world in a state of hibernation, World War II gave an opportunity for American designers to flourish and for designers from other countries came to America to start their business. American designer **Claire McCardell** designed comfortable separates (separate items of clothing) thus introducing the very popular category of sportswear.

Meanwhile most people recycled old garments and used clothing coupons. Regulations governing the clothing industry were introduced. No more than four meters of cloth could be used for a coat and one meter for a blouse. Specification for width of waist belts, shoes with thick wooden wedge-shaped heels, shoulder bags to carry supplies for wartime emergencies were clearly stated. Skirts were designed with side slits to make it easier to ride a bicycle.

Meanwhile in England a committee of designers was constituted to design a limited number of practical and attractive clothing for mass production. These designs called *Utility Clothing* were required to be within the parameters of textile restrictions enforced since 1941. The famous women's uniform called the Victory Suit is attributed to this committee.

The extravagant, '*New Look*' with its short, full skirt and short jacket introduced by French designer **Christian Dior** in 1947, established Paris once again as the fashion power base. The end of war also marked the end of austerities. After the liberation, the new post-War period saw the gradual revival of the clothing industry and rebirth of elegance. International linkages were strengthened. The clear need for both practical daytime dresses as well as luxurious evening gowns was balanced. The concept and establishment of exclusive stores called boutiques, made designer creations more accessible to the general public.



Fig 1.37 The 'Victory suit' during World War II



Fig 1.38 Christian Dior's 'New Look' in 1947

Exercise 5a: Fill in the blanks:

1. The French name of high fashion is _____.
2. The French name of ready to wear is _____.
3. White knit ensembles worn for sports like tennis were called _____.
4. The restrictions called _____ in clothing were enforced on the general public during World War II
5. The women's uniform during World War II was called _____.
6. _____ designs gave women the freedom to mix and match their clothes.

Exercise 5b: Match the following:

1	Practical elegant clothing	Christian Dior
2	Avoided designing corset dresses	Jean Patou
3	Use of bias grain on fabric	Elsa Schiaparelli
4	Whimsical motifs on clothes	Madeline Vionnet
5	Creator of the 1920s Flapper Look	Paul Poiret
6	New Look	Coco Chanel

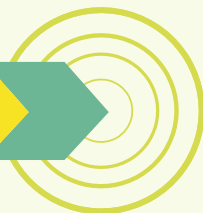



Review questions

1. List 4 inventions which brought improvement to the textile industry during the Industrial Revolution.
2. Name the women designers who dominated the period between the two World Wars.
3. List three regulations governing the clothing industry.
4. Explain 'Utility Clothing' during World War II?

Activity – 5

Background: There were some designers who made significant contribution to fashion during or between the two World Wars. Their design innovations had a widespread effect on the way clothing was perceived by society.

This activity will enable students to understand the creative role and significant achievements of fashion designers in the early 20th century

1. Select any one designer from the period during or between the World Wars
2. Find pictures of his/her designs from reference books or from the internet.
3. Paste the pictures in an exercise book relating them to the textual information in this chapter
4. Does the label still exist? If so, who is the Head Designer of the label now?

1.6 Evolution of Modern Indian Fashion

Traditional Indian clothes have had a distinct identity not only within the country but also globally. Moreover, Indian costumes have a unique characteristic of being indicative of a particular geographical region. The history of 20th century Indian fashion is contextual and co-related to the socio-economic-political environment within the country as well as changing fashion trends abroad. It should be noted that Indian heritage and tradition has been so deep-rooted that new influences could bring about only a limited amount of change, without any radical metamorphosis in culture.

1900 to 1910

At the turn of the century, the socio-political scenario was that of the British Raj firmly entrenched in India. On one hand the influence of Western fashion in menswear was seen in baggy trousers, buttoned shirts, jackets, hats, walking sticks worn by some Indians in the workplace. However dhotis and pajamas with kurtas and turbans continued to be the staple items of clothing for most people, indicative of regional or national identity.

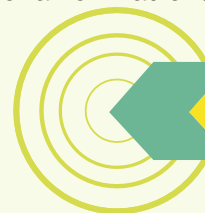

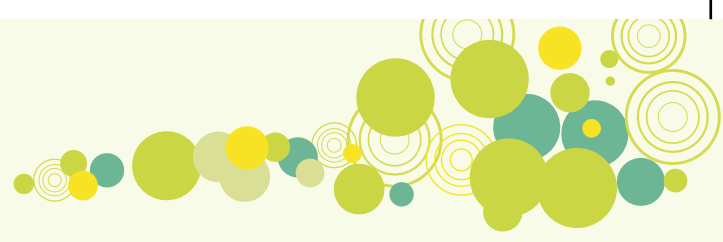

Women wore a high collared three-quarter sleeved blouse with the sari pinned on the left shoulder with a brooch. The wives of those working for the colonial government were the first to step out and mingle with the British. The ladies of *Brahmo Samaj* of Bengal were the earliest to adapt to Western styles. While the tradition of wearing saris with regional draping variations continued to be firmly entrenched, women began to experiment with the sari blouse. The stitched sari blouse echoed the latest styles of English blouses with cuffs, laces and pleats with the sari *palla* pinned at the shoulder. The long ruffled skirts worn by the English inspired the stitched petticoats worn with saris decorated with pretty borders and dainty laces. Heavier embroidery embellished with pure silver and the *resham* combined Mughal inspiration with Western influence.

1920s

In the West, the decade called 'Roaring Twenties' characterized by the 'Flapper' style enhanced the slender columnar silhouette. In India the trend was echoed with changes in the sari blouse where the semi-fitted rectangular shape continued in the long-sleeved blouses with raised sedate necklines.

1930s

This trend continued into the 30s where the sari *palla* was draped either *seedha* (back to front) or *ulta* (front to back). The Western style of padded shoulders translated into puffed sleeved blouses. This era saw the advent of movies which transformed film stars into icons whose every nuance of style was faithfully emulated by the masses. With the first talkies, elegant chiffon saris became fashionable popularized by the upper echelon of society and film stars. The first fashion show was held in Pune in 1930 when Catherine Courtney of 'Pompadour Gowns' presented western clothes on European models.

1940s

Austerity measures along with a renewed zeal in patriotism marked this decade. Mahatma Gandhi's call for complete independence in the 1940s had the objective of uniting the entire country and manifested itself by the burning of all foreign materials/clothes. It was a significant gesture that '*khadi*'- traditional, rough, homespun which was woven on the '*charkha*' was not just a fabric but also a symbol of the Indian spirit of the times-of self-reliance, nationalism and resistance to British rule. Khadi kurtas, pajamas and *dhotis* were worn along with the simple folded Gandhi *topi*. This look submerged differences in religion, creed and caste into one collective identity of being Indian. **Kamaladevi Chattopadhyay** epitomized Indian elegance in her hand women saris. Generally, women wore saris with conservative waist-length semi-fitted blouses with high neck or band collar and half-length, half three-quarter length or full length sleeves.

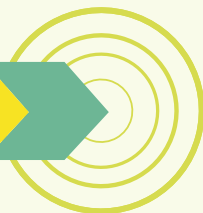



Post-independence and 1950s

Post 1947, the limitations of the Indian style statement was expanded by India's first Prime Minister, Pandit Jawaharlal Nehru. He consistently exhibited an inimitable style with his well-stitched churidar-kurtas, Gandhi topi and a '*bandhgala*' band-collar jacket with a red rose pinned on the lapel. The '*Nehru jacket*' as it was known, gave a new direction to menswear fashion in India.

The post-Independence era brought about a buoyant mood which continued in the 1950s, where the sari blouse showed distinct signs of innovation in pattern. The length of the blouse became shorter. The '*cup*' could now be cut as a separate piece with darts and seams. Embellishment through embroidery, mirror work, beads and sequins made blouses more decorative.

Indian women now had the dual responsibility of balancing the household and work outside the home. Optimizing time, she found the '*salwar-kameez*' very convenient. Originating from Punjab, this ensemble was adopted as a natural choice irrespective of local and provincial influences. It was initially worn with a short jacket or '*bundi*' and a '*dupatta*'.

1960s

This decade was the beginning of street wear bubbling up to high fashion, the ethnic look to hit the runway as well as for hippies to run free. In the West, the mini skirt/dress, shot up above the knees often teamed with knee-high boots. Correspondingly the '*salwar-kameez*' lengths grew shorter. '*Tights*' worn with skin-fitting knit tops and pullovers was an integral part of the look. Hindi films held up a true mirror of fashion in society of the time. Heroines wore extremely tight *kameezes* with *churidars* which were replaced by nylon stretch pants and '*dupattas*' of sheer materials like chiffon, net or nylon.

With sari blouses the craze for curvaceous toned midriffs continued. The back neckline plunged or could be knotted in a bow on a sleeveless blouse worn with sari with rather short '*palla*' seemingly carelessly thrown over the shoulder. Worn below the navel, saris were draped versions of low waisted '*hipster*' skirts and pants. Another variation was the mini-sari draped above the knee which was perhaps too risqué to become a widespread style statement. Hindi films gave the first stitched sari, figure-hugging with pleats and '*palla*' in place which just needed to be zipped up. This zip-on sari became a party-wear favourite because of the convenience of wearing it. Sensuous fabrics like chiffon, crepe and georgette were conducive to this sari drape. Bouffant hair with occasional hints of a fringe, heavy lidded eyes and pale lips completed the look.

This decade was synonymous with trousers called '*Bell-bottoms*' with varying degrees of



flare, a style that continued into the next decade. Loose, straight-leg trousers named 'Parallels' pre-dating modern wide-legged Palazzo pants were also fashionable. Indian kameezes were also teamed with these pants.

The *kurta/kameez* was also teamed with the lungi a wrap-around skirt either as a rectangle or as a large cylinder that could be draped on any body size. This was essentially a sarong-like wrap which was seen not only in the Orient but was also a traditional draped with regional variations seen in Saurashtra in the West, Kerala in the South and Punjab in the North.

Lucknow shararas and ghararas worn with kameezes and dupattas became part of the formal dress code. Another ensemble that became popular was the Rajasthani, *ghagra-choli* ensemble adopted by socialites at weddings and other traditional ceremonies. The long or short *ghagra skirt* was worn with stylized *cholis* and *kurtis*.

With *Femina* acquiring the franchise to several international beauty pageants like Miss Universe, Miss World and Miss Asia in 1965, beauty competitions and fashion shows were held in Delhi, Bangalore, Calcutta and Madras.

1970s

This was a time when the clash of lifestyles and aesthetic values resulted from the widespread use of new materials and techniques. Plastics replaced natural materials, factory produced goods replaced handcrafted ones and nylon replaced hand-woven silks and cottons. Yet against all odds, a strong revivalist movement revitalized the legacy of textile crafts largely through the efforts of visionaries like **Kamaladevi Chattopadhyay** and **Pupul Jayakar** who set up several institutes and organizations to energize the textile industry and to encourage the continuance of traditional handicrafted skills of artisans. The cottage industry found a strong Government supported infrastructure. Revival through recognition of national cultural roots came from fabrics, clothes and accessories designers. **Ritu Kumar** was one of the earliest pioneers of fashion with extensive research into block prints and innovative application of the technique of *zardozi embroidery*.

Radical options in draping the sari in the Coorgi style, leaving the shoulders bare, the butterfly style and the lungi style were seen. Backless embroidered blouses teamed with cotton saris. Both the *churidar-kurta* and the *salwar-kameez* were equally popular with the paunchaor stiffened hemline of the latter becoming extremely wide with the occasionally hazard of getting stuck in the 'platform' heels. Dupattas were either in a contrasting colour or else of the same print and colour as the '*suit*' itself.

1980s

Globally, 'power dressing' with padded shoulders, a tightly belted waist and a hip length

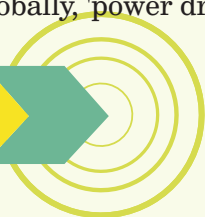



peplum was the characteristic silhouette. Indians responded with *kameezes* and tops with shoulder pads and leg o' mutton or puffed sleeves tapering to the wrist both of which usually visually widened the shoulder width. The waist was belted, tucked or sashed. Below were 'dhoti' pants, cowed pants, harem pants, or '*Patiala salwar*'

The revivalist movement continued its momentum with independent as well as government sponsored research projects and exhibitions both in India and abroad by stalwarts like **Martand Singh**, to showcase and promote India's varied textile tradition and crafts. Talented designers like **Asha Sarabhai, Archana Shah, David Abraham** and **Rakesh Thakore** ('Abraham and Thakore') from National Institute of Design who created labels with a distinctive globally relevant look based on their deep knowledge of textiles. Satya Paul, **Hemant Trivedi, James Ferriera, Pallavi Jaikishan, Abu Jani and Sandeep Khosla** ('Abu Sandeep'), **Monapali**, late **Rohit Khosla, Tarun Tahiliani, Suneet Varma, Ravi Bajaj, Rohit Bal, Rina Dhaka** were among the designers who commanded an impressive following of admirers.

1990s

This decade saw a multitude of influences, an eclectic mix with the return of chic, glamour and high-fashion. With rapid strides in communication, fashion shows in any part of the globe could be transmitted instantaneously by satellite. In India, TV channels like 'FTV' and 'Trends' along with programmes like '*MTV House of Style*', '*CNN Style with Elsa Klensch*' brought the latest fashion to living rooms. On one hand, therefore, for the urban consumer, was the awareness and acceptability of western clothes, to look 'cool' as dictated by style icons on MTV and be among the elite who wore Gucci and carried Louis Vuitton bags. On the other hand, was the need for ethnic clothing for semi-formal and traditional occasions like weddings and festivals. These high-priced 'haute couture' (high fashion) garments were expensive not only for their 'designer' label but also for the high level of skills of the embroiderer and the quality of materials used. In the context of the masses, grew a parallel prêt-a-porter (ready to wear) industry catering to the middle class by its volume in sales and affordability in prices. This decade saw the beginning of branding and the emergence of departmental stores and large single brand stores. To entice more customers to patronize the label/brand, there was widespread advertising from press releases, catalogues, magazines, hoardings to video ads. Fashion shows became a very effective mode for publicity both for designers and brand promotions. Designers like **Raghavendra Rathore, Wendell Rodericks, Anamika Khanna, Aki Narula, Rohit Gandhi and Rahul Khanna, Meera and Muzzafar Ali** also established their labels with distinct signature styles.

To tap the purchasing power of the Indian consumer, designers like **Zandra Rhodes (UK), Pierre Cardin (France), Ichiro Kimijima** and **Kansai Yamamoto (Japan)**



held promotional shows in India. Some brands like **Pierre Cardin** and **Ted Lapidus** launched their labels in India but could not sustain long term success.

The establishment of the **Fashion Design Council of India (FDCI)** in 1998 provided designers an organized forum for discussion and decision-making pertaining to the business. The annual **Lakme India Fashion Week (LIFW)** which started in 2000, provided several designers with the opportunity to showcase their creations to a wider audience, including national and international buyers. Today LIFW is considered to be a forum showcasing fashion associated with cine stars. In Delhi, FDCI organizes bi-annual Fashion Weeks for ready-to-wear, Couture Week and Mens Fashion Week. Bridal Asia showcases the exclusive creations in wedding trousseau wear.

With the establishment of the National Institute of Fashion Technology in 1986, a new wave of designers began to create designs which put India firmly on the global map. **Ritu Beri, JJ Valaya, Ashish Soni, Narendra Kumar Ahmad, Ashima Singh** ('Ashima-Leena'), **Ranna, Sonam Dubal, Sunita Shankar, Rajesh Pratap Singh, Manish Arora, Namrata Joshipura, Puja Nayyar, Sabyasachi Mukherjee, Shantanu Goenka, Gaurav Gupta, Nida Mahmood, Pankaj and Nidhi, Shalini and Paras** ('Geisha Designs') and others are synonymous with contemporary Indian fashion. Each designer label has distinctive design aesthetics and a style recognizable by the fashion fraternity. Each label is associated primarily with either Indian or western styles, women or men's clothing, elaborate surface embellishment or pattern-making oriented, minimalist or flamboyant etc.



Ashish Soni



Ritu Beri



J J Valaya

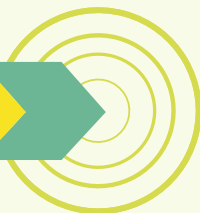

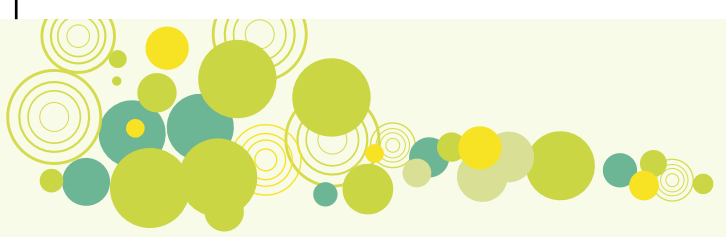

Ranna



Rajesh Pratap Singh



Sabyasachi Mukherjee



Namrata Joshipura

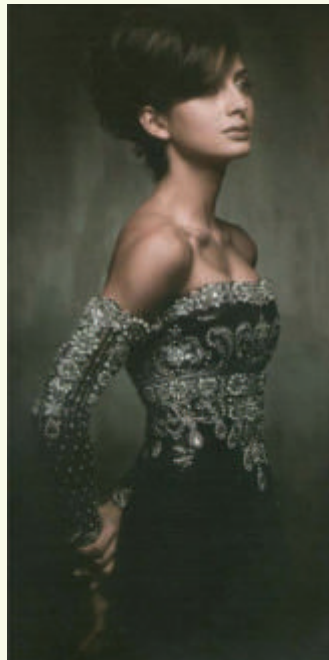

Rabbani and Rakha



Gaurav Gupta



FASHION STUDIES

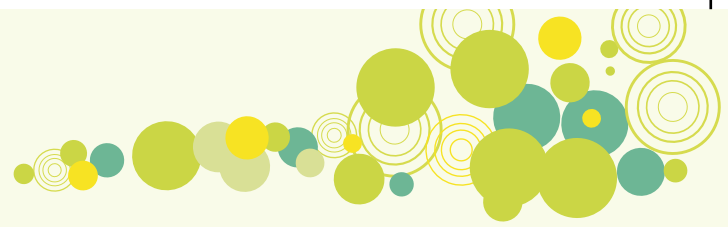

Sanskar by Sonam Dubal



Nida Mahmood



Joy Mitra



Geisha Designs by Shalini and Paras



Tanvi Kedia



Shantanu Goenka

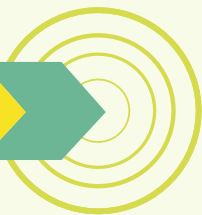



Designers strike a balance between creativity and commercial viability with keen business acumen. Some designers like **Amit Aggarwal**, **Rimzim Dadu**, **Alpana-Neeraj**, **Tanvi Kedia**, **Kallol Datta**, **Himanshu** and **Smita** (CELLDSGN 11.11) experiment with modern technology to innovate structures through materials and techniques. **Shivan-Narresh** have created their niche in swimwear and resortwear. **Aneeth Arora** ('Pero'), **Rahul Mishra** have created its signature styles through the re-interpretation of handcrafting traditions with sustainable business practices. **Samant Chauhan** works exclusively with fabrics from Bhagalpur, **Nitin Bal Chauhan** works with artisans in Chamba, **Uma Prajapati** ('Upasana Design Studio') involves community participation in Tamilnadu with an abiding commitment to sustainable fashion practices.



Payal Pratap Singh



Alpana Neeraj



Amit Aggarwal

The waves of liberalization and lowering of international trade barriers are sweeping the world. Opening up of the Indian market has heightened the awareness that design has to play a more significant role than ever before. Other countries are looking at India as a market leader because of its large population and potential customer base with purchasing power. With the entry of several international brands of apparel, accessories, jewellery, furniture and other lifestyle products, the Indian fashion market scenario is competitive, challenging and exciting. The rise of the luxury market is indicative of the increasing numbers of billionaires in India. The co-existence of foreign labels with domestic corporate brands, mass-produced labels with



handcrafted one-of-a-kind ensembles implies that there is a requirement for designers, textile and clothing technologists and merchandisers with talent, in-depth understanding of the industry, skills and a professional attitude related to the fashion business.



Aneeth Arora for 'Pero'



Shivan Narresh

Indian Designers on the Global Runway

New York Fashion Week: Ashish Soni in 2005, Sabyasachi Mukherjee in 2007, 2008

Paris Fashion Week: Rajesh Pratap Singh in 2008, Anamika Khanna in 2007, Manish Arora debuted in 2007

Milan Fashion Week: Sabyasachi Mukherjee in 2004, Rocky S in 2005, Tarun Tahiliani in 2004

London Fashion Week: Manish Arora in 2005

Exercise – 6

Fill in the blanks

1. Wills India Fashion Week (WIFW) in Delhi is organized by _____.
2. Lakme Fashion Week is organized in the city of _____.
3. An event which showcases wedding wear is _____.
4. Wedding wear is also called _____.

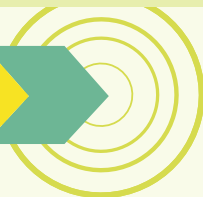



Review questions

1. What was the role of Kamaladevi Chattopadhyay in terms of textile and crafts revival?

Activity

Background: Contemporary Indian fashion showcases and promotes India's varied textile traditions and crafts with distinctive design aesthetics recognizable by the fashion fraternity through FDCI or LIFW. Each label is associated with Indian or western styles, women or men's clothing, elaborate surface embellishment or pattern-making oriented, minimalist or flamboyant etc.

This activity will enable students to know more about Indian designers.

1. Create a Power Point Presentation on any Indian designer:

The PPT should include the name(s) of the designer/label, date of establishment, location, stores where the label is available, participation in shows/fashion weeks, significant achievements, awards (if any), and unique characteristics.

Show the growth of the label through visuals tracing its history since inception to the latest collection.

7. Films and Fashion

India is the producer of the largest number of feature films in the world with centres for film-making such as Mumbai, Kolkata, Chennai and Hyderabad. However it is Bollywood (originating from the original name of Bombay) in Mumbai which, in particular, produces hundreds of films annually, inspires dreams among many. In India, Hindi films have a tremendous reach into the homes and hearts of millions.

The star status of movie actors makes them celebrities. This is the reason for the effectiveness of product endorsements by stars. Advertising practitioners rely on a celebrity face to stand out among innumerable advertisements and expect the likeability of the star to transfer to the product. Their performances create an illusion of interpersonal relationships with viewers. Even though the relationship is imaginary, people identify with them. Social behaviour and consumer purchasing is after influenced by media personalities because they are perceived as reliable advisors and role models.

Costumes in movies are very influential in creating distinctive styles and looks which stimulate fashion trends across the nation. The screen image of Amitabh Bachchan in formal sherwanis in *Mohabatein*, Aamir Khan in stylish formals in *Ghajini*, Salman



Khan in khakis and aviator shades in *Dabangg*, Shahrukh Khan in chic casualwear in *Kal Ho Na Ho*, Rekha in flowing Anarkali-like kurtas in *Umrao Jaan*, Bhagyashri in hand painted kurta-churidar in *Maine Pyar Kiya*, Madhuri Dixit in a purple sari in *Hum Apke Hain Kaun*, Kareena Kapoor in short kurtis and T-shirts with salwars in *Jab We Met* and others have influenced many other commercial designers and manufacturers to capitalize on the 'style wave'.

Costume designers are those who design and accessorize the clothes worn by actors onscreen. **Bhanu Athaiya** who has designed for several movies including *Lagaan*, conducted prior in-depth research to establish historical authenticity before finalizing the costumes for Sir Richard Attenborough's *Gandhi*. She won the Academy award for Best Costume Design for this movie in 1983. **Shama Zaidi** designed costumes for several award winning films including the Satyajit Ray's National award winning *Shatranj Ke Khiladi*. However in many period films based on historical events and characters, the costumes may or may not be credible in their interpretation; sometimes the lavish production, elaborate sets and a glossy look may merely require correspondingly glamorous costumes.

Some more examples of designers/ costume designers and a few of their most recognizable movies are:

- + **Aki Narula** *Bunty aur Babli, Don*
- + **Ameira Punwani** *Guru*
- + **Arjun Bhasin** *Dil Chahta Hai, Lakshya, The Namesake, The life of Pi*
- + **Dolly Ahluwalia** *Omkaara, Bhaag Milkha Bhaag, Water, Bandit Queen* (National award for Best Costume)
- + **Leena Daru** *Tezaab*
- + **Lovleen Bains** *Rang De Basanti*
- + **Niharika Khan** *Band Baaja Baaraat, Rock On, Delhi Belly, The Dirty Picture* (National award for Best Costume)
- + **Neeta Lulla** *Jodha Akbar, Devdas* (President award)
- + **Priyanjali Lahiri** *Tare Zameen Par*
- + **Sabyasachi Mukherjee** *Black* (National award for Best Costume)

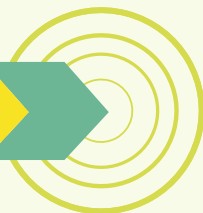



Today designers for movie stars, both on-screen and off-screen have a celebrity status of their own. Moreover, film-making has become more organized as an industry with the entry of professional fashion designers as costume designers designing for stars both on-screen and off it. The relationship between designer and actor was best exemplified by designer Givenchy with actress Audrey Hepburn as his inspiration or 'muse' in the 1950s. In Hindi films there are similar examples such as **Manish Malhotra** who designs and styles Karishma and Kareena Kapoor, **Sabyasachi Mukherjee** for Rani Mukherjee and Vidya Balan, **Neeta Lulla** for Aishwarya Rai and so on. Designers like **Rocky S, Vikram Phadnis, Surily Goel, Anna Singh, Arjun Bhasin** also design for movies. **Anaita Shroff Adjania**, fashion editor for Vogue India has designed the costumes and styled the look in *Dhoom*, *Dhoom 2* and *Love Aaj Kal*. **Muzaffar Ali** director of *Umrao Jaan* is also a fashion designer. The two movies *Fashion* and *Heroine* directed by **Madhur Bhandarkar** showed a range of glamorous clothes on-screen which are associated with fashion and costume designers.

Both movies and television are significant in creating and showcasing new styles that have become iconic, spreading like wildfire, capturing the imagination of the masses. These on-screen costumes have started trends resulting in mass buying of similar styles at affordable price points. The actors, the screen characters and the clothes they wear in commercially successful movies and serials, become influential factors in the clothing and lifestyle choices for the masses and create market demand for the same styles.

Exercise – 7

Name the costume designer of the following movies

1	Black	
2	Gandhi	
3	Life of Pi	
4	Taare Zameen Par	
5	Umrao Jaan	
6	Devdas	

Activity 7

The costumes worn by screen characters in successful movies and television serials, are influential in creating market demand for similar styles at affordable price points.



FASHION STUDIES



This activity encourages students to understand the impact of reel-life movies and costumes on real-life markets and trends.

1. Identify a movie which has won award(s) for best costume.
2. Analyze the costumes of the lead characters in terms of elements and principles of design
3. Refer to magazines and newspapers to find out the extent to which the styles have trickled across different consumer segments.

References:

'Concept to Consumer' by Gini Stephens Frings. *Prentice Hall*

'Fashion Design- the complete guide' by John Hopkins. *Ava Publishing*

'Street style: From Sidewalk to Catwalk' by Ted Polhemus. *Thames and Hudson*

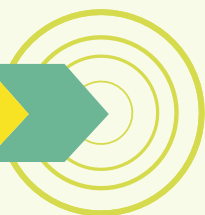



Glossary

Angarkha Long fabric coat originally worn by the Mughals over the chain mail which passed into society as civilian clothing

Antariya Draped lower garment for both sexes in India

Camouflage print Print used in clothing and accessories in specific patterns and colour combinations used by the army and other security forces.

Chilta Hazaar Masha Coat strengthened with studs/nails on fabric reinforced with plate armour worn by the Rajputs

Chintz Small print derived from Indian word *cheent*

Chiton Draped rectangle of fabric which could be belted to form a tunic or draped like a shawl fastened on one or both shoulders worn by Greek men.

Fibula Decorative pin or brooch used to secure ends of the garment at the shoulder by Greeks and Romans

Haik Large transparent material around the body knotted at the waist creating elaborate folds at the hips worn by Egyptian male royalty

Haute Couture French term for exclusive, one-of-a-kind 'high fashion'

Himation Large fabric worn by Greek men swathed around the body without fixed fastenings with or without inner garment

Jootis Traditional footwear in India

Kachcha Unstitched piece of fabric draped around the hips or draped loincloth for men, passed between the legs with the end tucked at the centre front waist worn in India.

Kalasaies Egyptian unisex sheath-like tunic

Kaunakes Ankle-length, wrap-around skirt tied at the waist with the excess waistband hanging loosely at the back worn by the Sumerians.

Kavach Indian waistcoat of armour for the torso

Kayabandh Indian sash fastened at the waist knotted at the front in simple or elaborate ways.



Khaki Dust-coloured lightweight cotton drill fabric used by the Indian army during the British Raj. In contemporary vocabulary, it can refer to the colour, fabric, details or garment.

Mauli Turban made of a twisted roll of cloth worn by the Kushans

Palla Draped garment worn by Roman women as the equivalent to the male toga.

Peplos Shawl worn by Greek women fastened at the shoulder either as Open peplos or Closed peplos

Schent Linen fabric wrapped around the hips worn by all classes in Egypt

Toga Worn only by free Roman citizens, it was initially worn outdoors and later became a ceremonial garment.

Ushnisa Turban twisted with the hair into a top knot and wound around the head for men worn in ancient India.

Uttariya Traditional Indian unisex upper garment, versatile both as formal and casual clothing whose drape indicated the profession of the wearer.

Photograph Courtesy

Sunil Sethi, President - Fashion Design Council of India

- | | | |
|---------------------|---------------------|--|
| • Alpana and Neeraj | • J J Valaya | • Payal Pratap Singh |
| • Aneeth Arora | • Joy Mitra | • Rajesh Pratap Singh |
| • Arun Kumar | • Manish Arora | • Ranna |
| • Ashima and Leena | • Manish Tripathi | • Ritu Beri |
| • Ashish Soni | • Namrata Joshipura | • Sabyasachi Mukherjee |
| • Atsu Sekhose | • Nida Mahmood | • Shalini Jaikaria and Paras Bairoliya |
| • Gaurav Gupta | • Pankaj and Nidhi | • Shivan and Narresh |
| • Himanshu Dogra | • Puja Nayyar | • Varun Bahl |

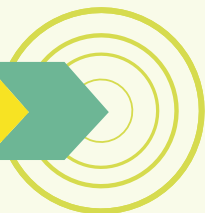



Chapter 2

Basic Pattern Development

2.1 PATTERN MAKING

2.1.1 Introduction:

Pattern Development & its origin

Pattern Designing is an extensive subject that covers principles of constructions and techniques in a wider perspective rather than style details. It opens opportunities for creating infinite styles. Pattern construction can be divided in two parts:

- i) Measuring correctly
- ii) Knowledge of technique with which they are applied.

Learning pattern-making by trial and error is like learning to play music by ear. The earlier methods of pattern making generally used shapes by copying and reconstructing them.

Several systems of pattern constructions were devised in the early days of tailoring, long before clothing industry came in existence. They served the needs of a busy tailor who generally required a guide for drafting garments directly on to the cloth. As each garment was cut individually to varying measurements, pattern drafting had to be simple and speedy in operation. Since speed was an important factor, systems were devised to include necessary seam allowances. The system now used for pattern development is called Block Method where seam allowances are calculated at the time of cutting the final pattern.

The human form comprises complex geometric shapes and presents problems in pattern construction. The accuracy of any cutting system depends largely on relevant and correct measurements. On the other hand, Proportionate Systems seem to offer a ready solution to the problem of unreliable or incorrect measurements. The Proportionate Systems work on the principles that the whole body is divided into eight heads and the girth measurements are in proportion to each other. Pattern makers generally tried to find an ideal system and did not realize that a system laid down by one method may not fully satisfy the needs of another human figure since no two human forms can be identical.

Pattern construction systems are largely dependent and influenced by the particular fashion of their period. Seam placement and suppression are an integral part of a draft wherein design cannot be altered without disturbing the garment balance. However experienced pattern makers invariably took the precaution of adding sufficient inlays or allowance in the main seam of garment as a safeguard against error of judgment.



Lack of reliable data on body measurements has, to a large extent, has been responsible for the continued used of systems based on theoretical proportional measurements. W. H. Hulme wrote in his book "The Practice of Garment Pattern Making wrote:

"The clothing industry has been prolific in systematic methods of applying descriptive data and it is fair to say that in many of these pattern systems the principles involved have not been too obvious, or even clearly stated. Several years of study of English. American and European pattern systems suggest that method may be unrelated to, or divorced from, principles. The widest variations exist in that large group of systems which not only do not state the principles applied, but which seem to proceed on the assumption that none exists, and that the whole operation is empirical".

"At the beginning let it be said that the word 'system' connotes something soundly based and rooted in reason, capable of being demonstrated and the results applied. If a point is fixed, or a part located for a sound reason, that reason can and should be given. If the working of a law is detected in a number of similar instances, that law should be capable of statement and proof".

Philip Kunick in his book 'Modern Sizing and Pattern Making for Womens and Childrens Garments' writes that it is still a common practice to teach pattern construction for the wholesale trade by means of a drafting scale based on a girth measurement, not only for fixing points or locating parts, but also for drafting a garment of any size. This is rarely done in the wholesale trade, where it is the general practice to cut a pattern in a standard size, indication that the exact dimensions are not known and proportionate measurements must be used as substitutes; with the result that extreme sizes, drafted to a hypothetical scale, rarely give a satisfactory fit.

Due to unreliability of cutting systems, many pattern designers started draping their patterns on a dress form. A skillful designer can achieve good results but this method is inefficient and time-consuming for the ready to wear market. The modern methods base their foundations on principles of draping in the two-dimension form balance. Balance is the underlying objective while manipulating pattern balance is a vertical relationship between the front and back. If the balance of a pattern is faulty it means that accuracy of all vertical measurements is lost.

There were just 18 pattern cutting books including that of Alcega published from the 16th century to the 19th century in Europe. This can be attributed largely to lack of literacy and numeracy prevalent amongst pattern makers, tailors and dress makers at that time. Traditionally the skills were passed to the apprentices through demonstration and verbal instructions.

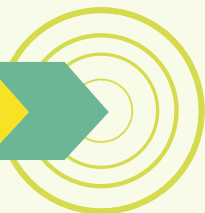



2.1.2 Pattern Making

Pattern making is *the process of transforming a design into its constituent flat pattern pieces and then drafting them out*. The job of a pattern-maker is to interpret the designs into sample pattern pieces and then drafting them. Pattern making covers principles of constructions and techniques in a wider sense rather than style details in a narrow sense (Armstrong, 2000). It opens scope for infinite variety of styles both for regular designs and innovative patterns. Pattern making can be divided in two parts namely measuring correctly & knowledge of technique devised to include necessary seam allowances. Measuring the human body is the precursor to developing garments to fit the body. Measuring scales range from simple measuring tape to complex body scanners and low to high tech.

Pattern for a garment is the blue print on the basis of which the fabric is cut and the same is achieved by two methods:

- + Flat Pattern Method
- + Draping Method

Flat Pattern Method is a method where in body or dress form measurements are taken for developing a pattern. Following a logical stepwise procedure, the measurements are then converted into a pattern. In other words this system depends on accurate measurements to complete the paper pattern. There are limitless designs, which can be achieved for workable garments. Flat pattern making should be done in conjunction with a dress form so that as the design evolves, proportion and balance in the garment can be checked side by side. It is important to transfer the pattern on to a muslin (toile pronounced as 'twall') to test the fit, on a dress form or a human figure.

Flat Pattern cutting is now widely used because of its accuracy of sizing and the speed with which complicated designs are made. It is a system of creating patterns by manipulating a basic block. It is widely used for the following reasons:

1. The basic block includes ease allowance which allows the body to perform a variety of normal body functions requiring movement of various body parts.
2. The method is logical and easy to understand.
3. It brings consistency and accuracy of both size and fit of mass-produced garments
4. It is also the fastest and most efficient pattern design method even for complicated designs.

Draping method is the oldest pattern making method and is generally regarded as a creative approach. In this method a piece of two-dimensional fabric is draped directly on a dress form or figure and made to fit on the dress form to achieve the desired look or shape. The fabric may conform to the basic shape of the form or be arranged artistically



in folds for a specific design. This muslin pattern is then transferred on the paper, and corrections are made, if any, and then the same are converted into a final pattern.

2.1.3 Terminology

I. Block/sloper

Sloper is a term given to a very basic set of pattern pieces used to make additional patterns of any style. It refers to paper cutting of basic bodice, skirt, sleeve or any such basic pattern from which all the other designs are developed. The Block normally represents the dimensions of a specific form or figure. It has darts to fit to the contours of the body but has neither any design features nor seam allowances. It is the foundation used to make the pattern of a design.

It is important that the correct block is chosen for the design; this not only saves time during adaptation but can affect the final shape. The basic blocks can be drafted to fit individual figures by using personal measurements instead of the standard measurements listed in the size chart.

Name of the block e.g. skirts front, bodice back etc.

- + Grain line
- + Size e.g. 32, 34, 36 or S, M, L

The block should carry the following information:-

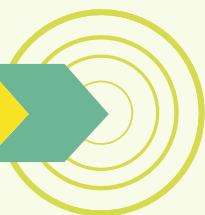
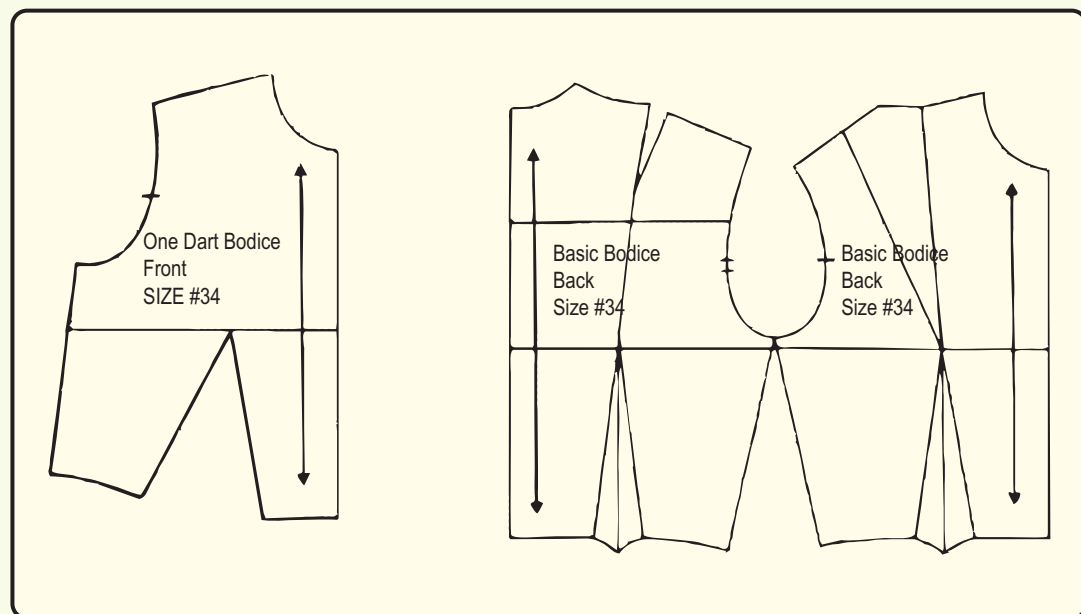

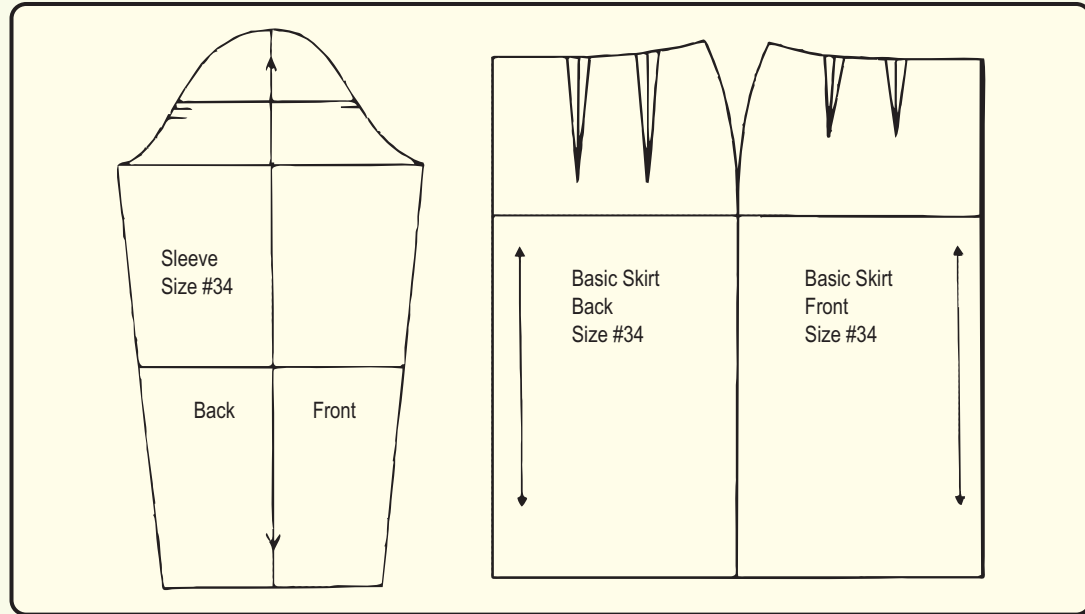

ii) Pattern

Pattern is developed from the block that includes all the information needed for cutting and production of the garment including seam allowance.

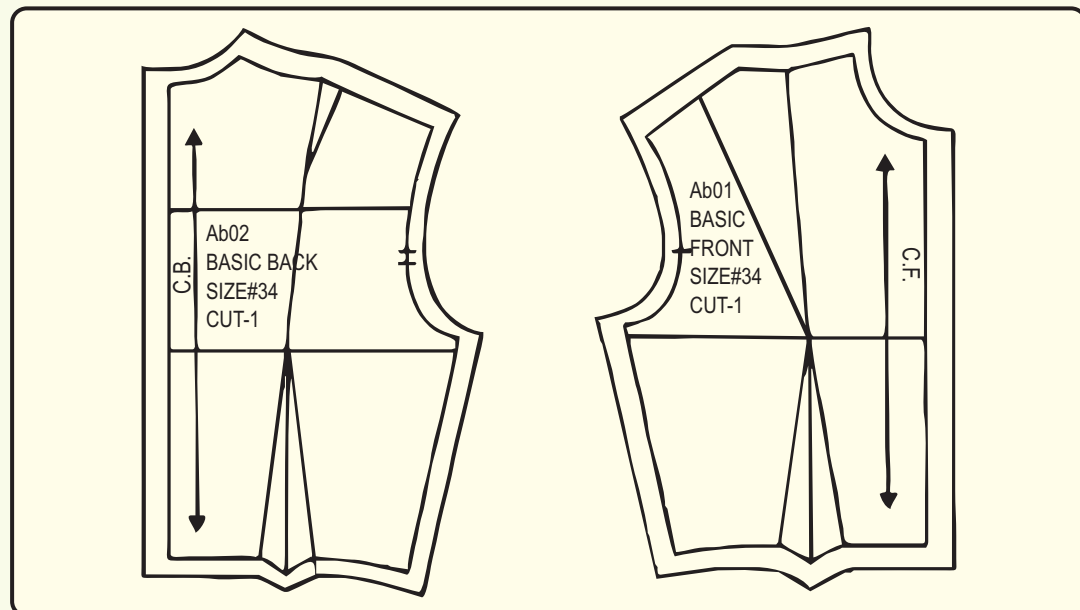

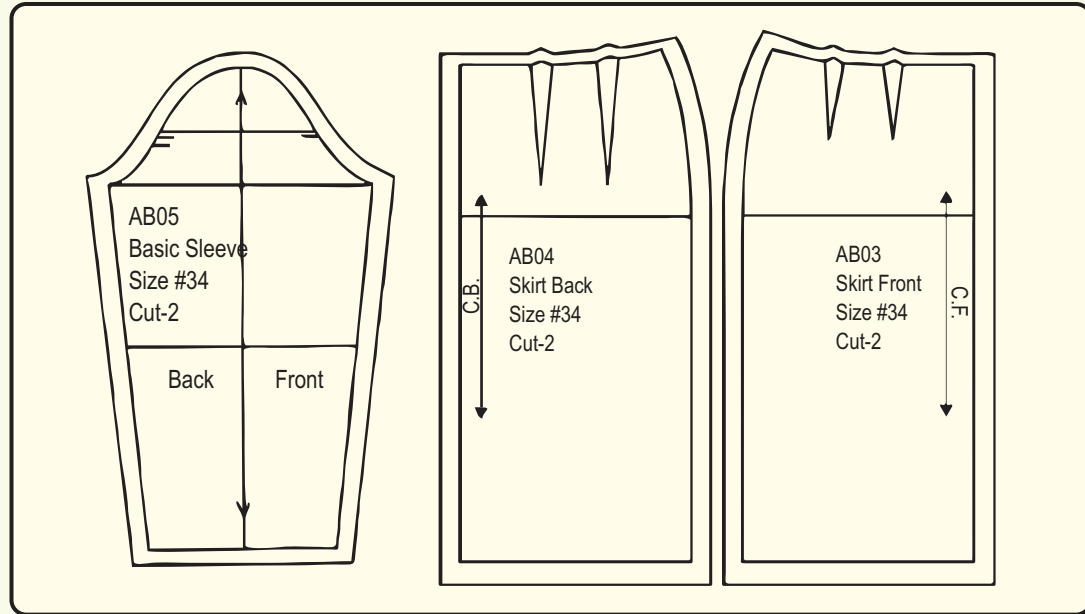

The following should be included on a pattern:

- + **Grain line**
- + **Centre Front or Centre Back**
- + **Style number or Code number** of the pattern set may which be evolved e.g. **AB 01** here AB identifies type of the garment and 01 identifies the piece number of complete set. If there are 5 pattern pieces in a garment, the pieces will be numbered as AB 01, AB 02, AB 03, AB 04 and AB 05.
- + **Pattern piece** e.g. skirt front, skirt back, side front etc.
- + **Size** as 32, 34, 36, or S, M, L etc.
- + **Cutting information** - It should be clearly mentioned as to how many pieces are to be cut e.g. Cut 1, Cut 2, Cut on fold.
- + **Notches** - Marks that are needed to help assemble garment sections correctly.
- + **Directional Fabrics** - For fabrics which have designs in one direction such as floral print, stripes, plaid, velvet, fur etc. A symbol "cut one way" or (?) is indicated on the pattern.
- + **Date** - Indicated as a reference point.
- + **Seam Allowances**

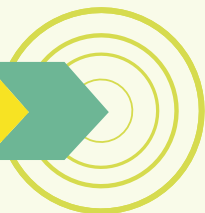



iii) Seam Allowances

The amount of seam allowance required for each seam line may vary depending on the location and end purpose. Generally these are the measurements followed:

- ¼" for sharp curves
- ½" for neckline, armhole, waistline, style line.
- 1" for side seam, centre line, shoulder, plackets.
- 2" for straight hem line.

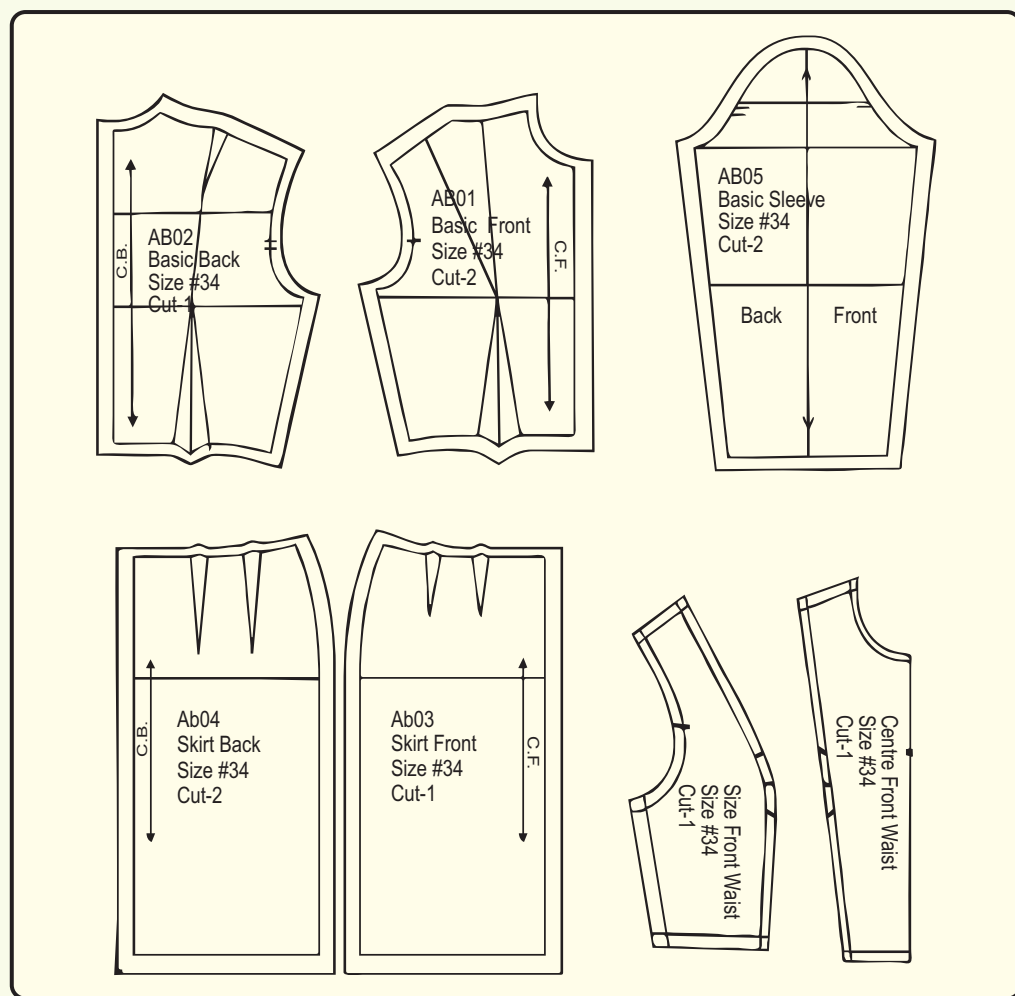

iv. Muslin

Muslin is used for making test fits. This is basically an unbleached plain woven cotton fabric available in light, medium and heavy weight. Medium quality muslin is generally used for test fitting and draping.



v. Grain line

Grain line is a line drawn from end to end on each pattern piece to indicate how the pattern should align with the lengthwise grain of the fabric. Whichever be the direction in which the grain line is drawn on the pattern, it will always be placed parallel to the selvedge on the fabric.

vi. Balance

Refers to hang and also proportions in garments. Fashion dictates balance to a certain extent, for example long tops over short skirts. Where flat pattern cutting is concerned it is often difficult to judge correct balance until the garment is actually made in fabric.

vii. Balance Marks

These are marks made on edges of pattern pieces that show where they are to be matched. They are a useful construction guide on all seams but where edges of different shapes are to be joined or where one edge is fuller than another, balance marks are vital. In pattern cutting make short pencil marks at the edge of the paper, copying them through all stages to the final pattern. On bought paper patterns balance marks are indicated by indicated by triangles and are referred to as notches

viii. Dart

Dart is a wedge-shape or triangular shape marked on the pattern that controls the fit of the garment.

Dart legs-The two sides of the triangular shape & should be of the same length.

Dart point - The point at which the dart ends.

Dart intake - The amount of suppression taken between the dart legs.

Apex - The highest point on the bust.

Darts radiate from the highest point of a mount on a body, these mounts are generally rounded. If the darts on front bodice are stitched till the apex they would create a point on the apex and strain the garment. The body is rounded and not pointed hence to avoid these strains or pulls on the garment the darts need to be finished away from apex.

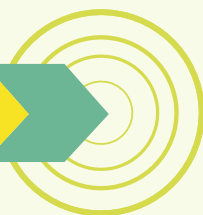

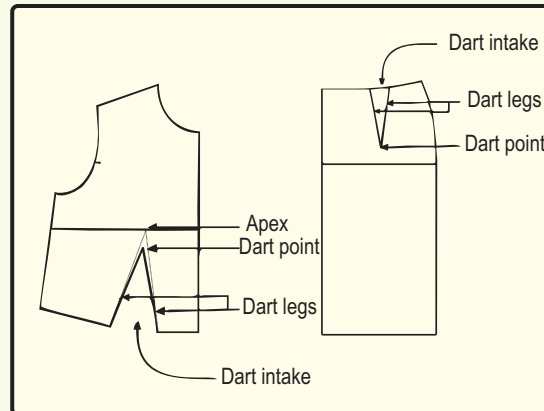

Single Dart Pattern

In this a single dart is there for entire suppression required. Dart ends $\frac{1}{2}$ " away from the bust point.

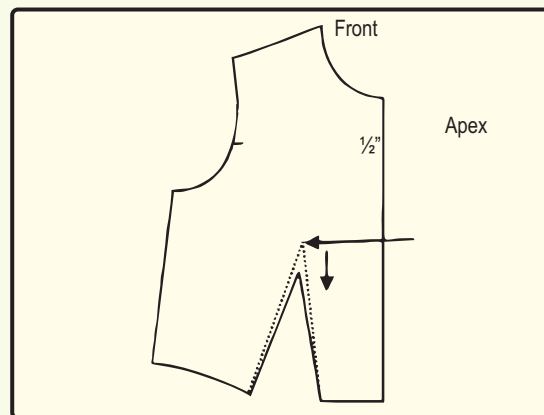

Two Dart Pattern

Waist dart is $\frac{3}{4}$ " to 1" away from the bust point.

Other dart is $\frac{3}{4}$ " to 1 $\frac{1}{2}$ " away from the bust point.

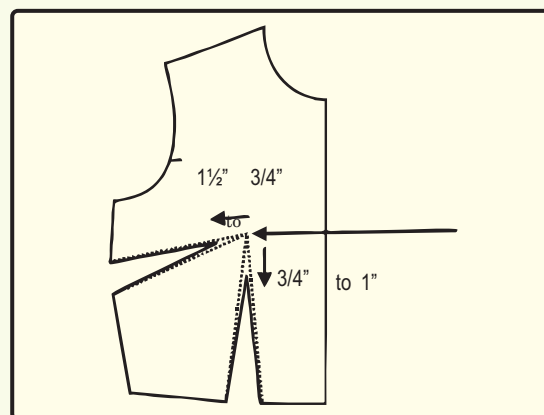



2.1.4 Symbols and Abbreviations

Centre Front	-	CF
Centre Back	-	CB
Grain line	-	
Notches	-	< ı
Buttons	-	⊖
Button hole	-	┌┐
Front	-	F
Back	-	B
Waist line	-	Wl
Arm hole	-	Ah
Side Seam	-	SS
Neck line	-	NI
Shoulder	-	Sh
Grain line on fold	-	
Gathering	-	
Pleat (arrows indicates direction of fold)	-	↔
Box pleat	-	
Two way grainline	-	↕
One way grainline	-	

Activity

Collect pictures of womenswear garments and create a folder/ style file.

Identify the type of darts and seams used in the garments.

Fill in the blanks

- A pattern can be cut by _____ method and _____ method.
- Pattern is a _____ of a garment.
- The author of the book 'Modern Sizing and Pattern Making for Womens and Childrens Garments' is _____.
- The dart is a _____ wedge that gives _____ to the flat piece of _____.
- Waist dart is _____ inch away from the bust and side seam dart is _____ away.

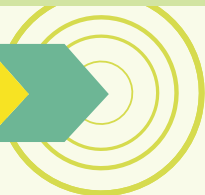



- f. Balance refers to _____ and _____ in a garment.
- g. Muslin is used for _____ a pattern and is also called a _____.
- h. Pattern is placed _____ on the _____ of the fabric.
- i. _____ is a term given to _____ set of pattern piece used to make patterns of _____ style.
- j. _____ method is the oldest patter making method and is regarded as a _____ approach.

Review Questions

1. What is Pattern Making?
2. Describe two methods of Pattern making
3. Why is it important to choose a correct block for design development?

2.2 Measurements

2.2.1 How to take Measurements

Care should be taken to take accurate measurements in order to achieve a good fit. It is extremely important to understand the dress form before starting to take dress form measurements. One should carefully observe the shape of the body, where it is hollow, how shoulder slopes etc.

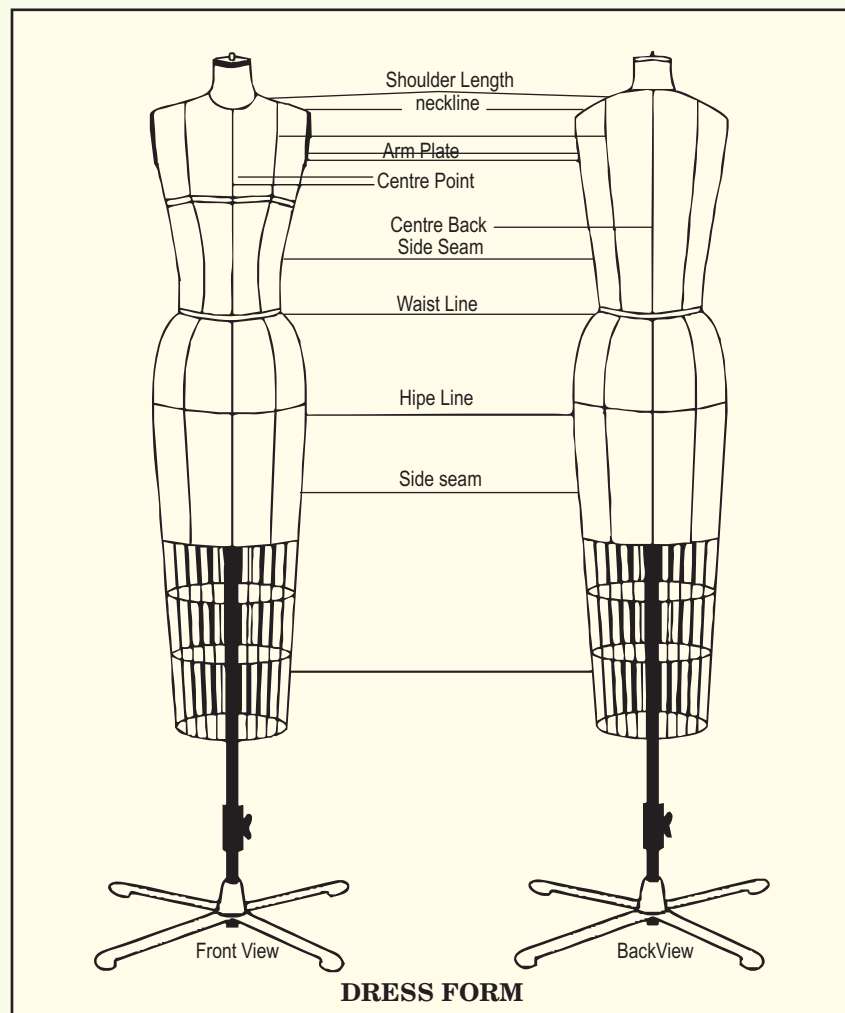

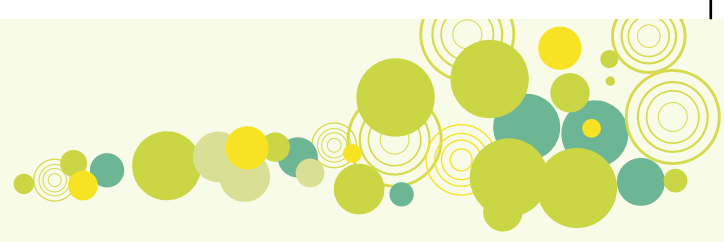

Measurements

1. **Front length** - Shoulder neck intersection to waistline over the bust, take care to measure with a hand under the bust.
2. **Centre front length** - Centre front neck intersection to centre front waist intersection.
3. **Shoulder to waistline** - Shoulder tip to side seam waistline intersection (over the sides)
4. **Underarm seam** - From a point X, 1" below the armhole to waistline intersection at the side seam.
5. **Shoulder length** - From shoulder neck intersection to princess line and from princess line to shoulder tip.
6. **Width of bust** - Width of bust measurement is from centre front over the bust to point X on side seam.
7. **Front waistline** - From center front waistline intersection to side seam waist line intersection.
8. **Front hipline** - Place a pin at 7" below the waistline on centre front line.

Using this measurement as a guide, from the floor, mark horizontally on the dress form, starting at center front and continue to side seam (keeping it uniform throughout). Put a style tape for reference and this is the hip line. On this line marked by style tape, take measurement from center front intersection to side seam intersection.

9. **Apex measurement** - From the centre front to the high bust point keeping the tape parallel to the floor.
10. **Centre Front to the Princess line** - From centre front intersection to princess line intersection at waistline.

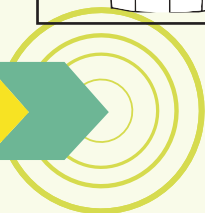
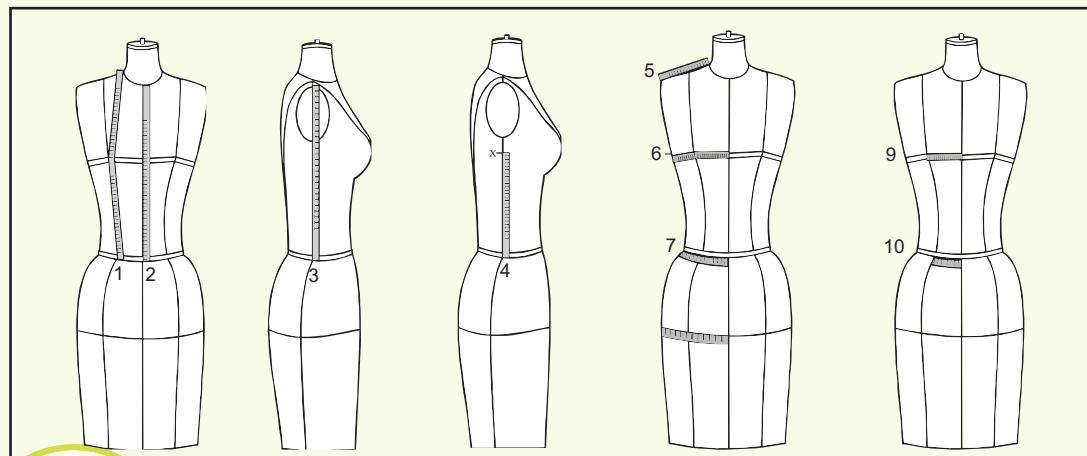



11. **Shoulder blade** - Mark a point Y on centre back such that, centre back neck intersection to point Y is equal to 1/4th of centre back length. Shoulder blade measurement is taken from point Y to armhole ridge keeping the tape parallel to the floor.
12. **Width of back** - From point X to centre back keeping the tape parallel to the floor.
13. **Back waistline** - From centre back waistline intersection to side seam waistline intersection.
14. **Back hip line** - From centre back intersection to side seam intersection on hip line marked by style tape.
15. **Centre Back length** - From centre back neck intersection to centre back waistline intersection.
16. **Centre back to princess** - From centre back intersection to princess line intersection at the Princess Line waistline.

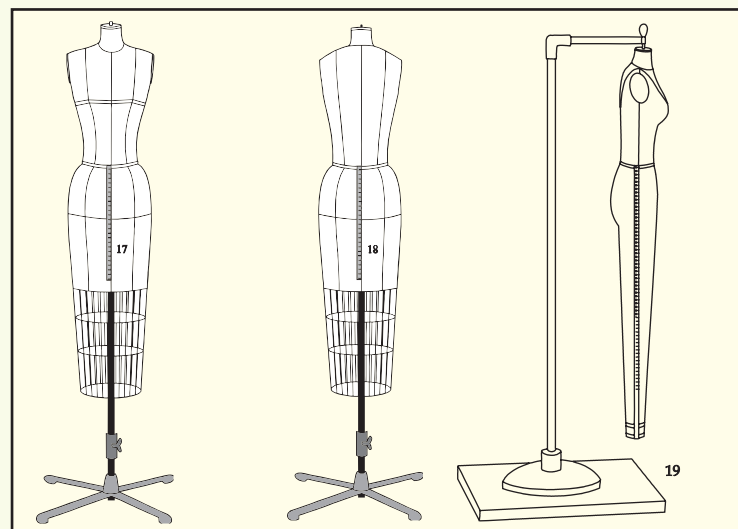
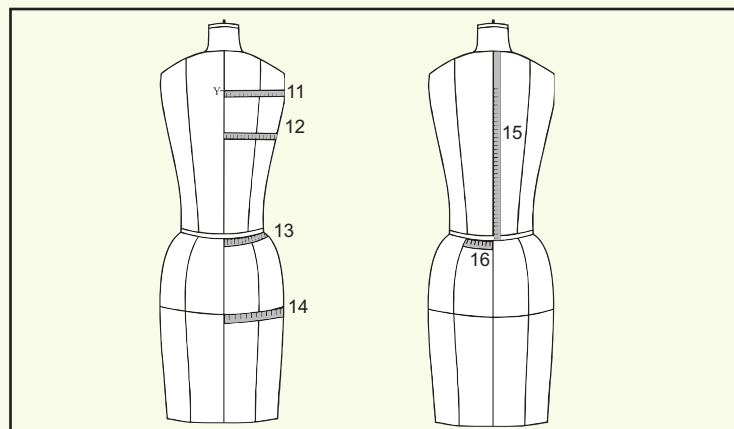



17. **Centre Front length for lower garment** - From centre front waistline intersection at centre front down to the desired length.
18. **Centre Back length for lower garment** - From centre back waistline intersection at centre back down to the desired length.
19. **Side Seam Length** - From waistline intersection at side seam over the hip to ankle.
20. **Crotch depth**
 - (a) On dress form - Place an L-square between legs of form and note the measurement at waistline. This measurement includes $1\frac{1}{4}$ " ease as the L-square is generally $1\frac{1}{4}$ " wide.
 - (b) On body - In seated position, measure from waistline intersection at side seam over the figure to the seat of the chair. (One needs to add ease here.)
21. **Knee Circumference** - Round measurement over the knee bone.
22. **Ankle Circumference** - Round measurement over the ankle bone.

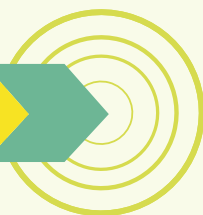
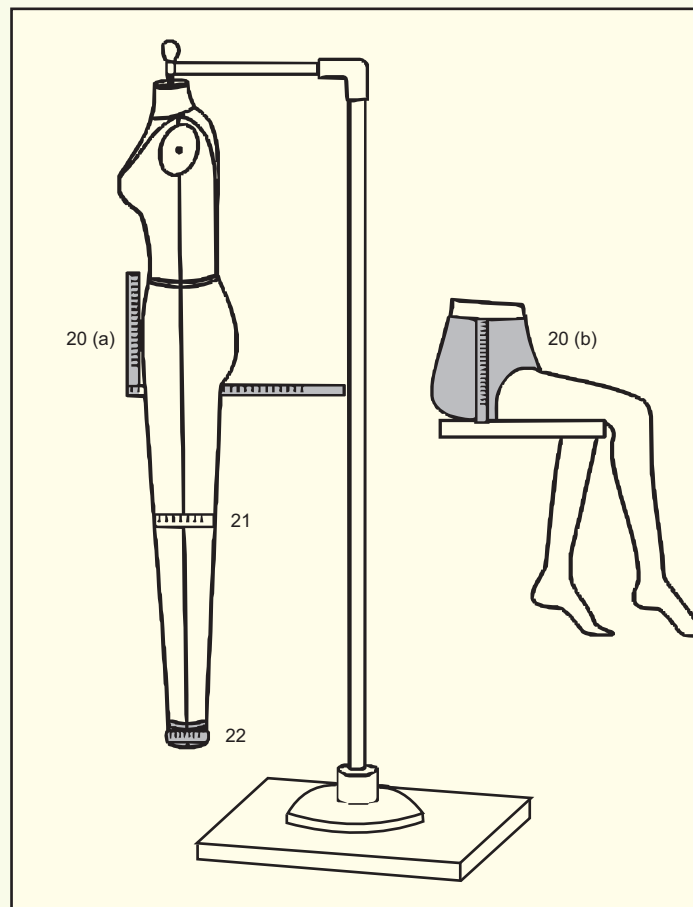



23. Cap height - Tie a tape around the biceps of arm close to the armpit. Cap height is from shoulder intersection to the top of the tape.
24. Sleeve length-From shoulder intersection over the bent elbow to the wrist.
25. Bicep Circumference - Round measurement to be taken over the fullest part of the arm.
26. Elbow Circumference - Round measurement over the elbow.
27. Wrist Circumference - Round measurement over the wrist bone.

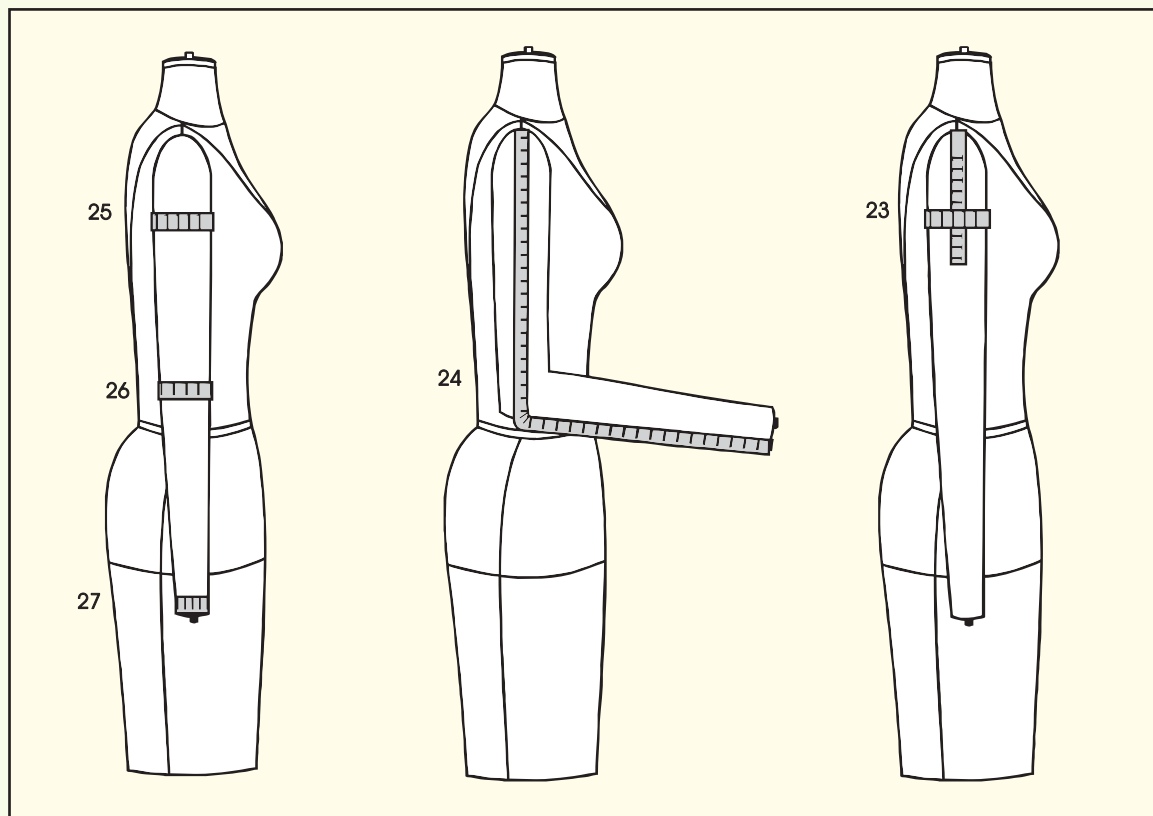

Activity

- Measure a dress form in the class.
- Measure your classmate whose body proportions resembles the dress form.
- What are the differences in the two measuring methods you use?

Fill in the blanks

- a. Center Front is the line that divides the front _____ in two _____.
- b. Ankle should be measured around the _____.



- c. Correct sleeve length is taken by measuring over a _____.
- d. Bodice length is measured by measuring from neck ____ to apex and waist by placing a _____.
- e. Crotch depth on a body is measured by making the _____ sit on a _____ surface and it is measured from _____ to _____.
- f. Apex is measured by taking the measurement from shoulder _____ to the apex point.
- g. Distance between the apex and center _____ is measured by _____ the distance between _____ points in _____.
- h. Shoulder blade level is measured at _____ of _____.

Review Questions

1. What are the 2 ways of measuring the Crotch Length?
2. How do you measure bust and shoulder length on the dress?

2.2.2 Standard Dress Form Measurement Chart For Bodice & Skirt (in inches)

SIZES	32	34	36	38	40	42	44
FRONT LENGTH	17 ^{1/4}	17 ^{1/2}	17 ^{3/4}	18	18 ^{1/4}	18 ^{1/2}	18 ^{3/4}
WIDTH OF BUST (1" below arm plate includes an ease of 1/2")	9 ^{1/2}	10	10 ^{1/2}	11	11 ^{1/2}	12	12 ^{1/2}
CENTRE FRONT LENGTH	14 ^{3/8}	14 ^{1/2}	14 ^{5/8}	14 ^{3/4}	14 ^{7/8}	15	15 ^{1/8}
APEX	3 ^{5/8}	3 ^{3/4}	3 ^{7/8}	4	4 ^{1/8}	4 ^{1/4}	4 ^{3/8}
UNDER ARM SEAM	7 ^{7/8}	8	8 ^{1/8}	7 ^{1/2}	8 ^{3/8}	8 ^{1/2}	8 ^{5/8}
FRONT WAISTLINE (includes an ease of 1/4")	6 ^{3/8}	6 ^{3/4}	7 ^{1/8}	8 ^{1/4}	7 ^{7/8}	8 ^{1/4}	8 ^{5/8}
WAISTLINE TO SHOULDER (includes an ease of 3/4")	14 ^{3/4}	14 ^{7/8}	15	15 ^{1/8}	15 ^{1/4}	15 ^{3/8}	15 ^{1/2}
SHOULDER LENGTH	4 ^{7/8}	2 ^{3/4}	5 ^{1/8}	5 ^{1/4}	5 ^{3/8}	5 ^{1/2}	5 ^{5/8}
CENTRE FRONT TO PRINCESS LINE	2 ^{5/8}	9	2 ^{7/8}	3	3 ^{1/8}	3 ^{1/4}	3 ^{3/8}
WIDTH OF BACK (1" below arm plate includes an ease of 1/2")	8 ^{1/2}	5	9 ^{1/2}	10	10 ^{1/2}	11	11 ^{1/2}
CENTRE BACK LENGTH	16 ^{1/2}	16 ^{3/4}	17	17 ^{1/4}	17 ^{1/2}	17 ^{3/4}	18
BACK WAIST LINE (includes an ease of 1/4")	5 ^{5/8}	6	6 ^{3/8}	6 ^{3/4}	7 ^{1/8}	7 ^{1/2}	7 ^{7/8}
SHOULDER BLADE	6 ^{7/8}	7	7 ^{1/8}	7 ^{1/4}	7 ^{3/8}	7 ^{1/2}	7 ^{5/8}
CENTRE BACK TO PRINCESS LINE	2 ^{1/2}	2 ^{5/8}	2 ^{3/4}	2 ^{7/8}	3	3 ^{1/8}	3 ^{1/4}

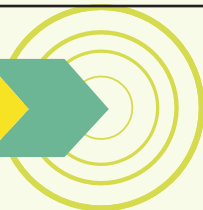



FRONT HIPLINE (7" below waistline)(includes an ease of 1/4")	9 ^{1/8}	9 ^{3/8}	9 ^{5/8}	9 ^{7/8}	10 ^{1/8}	10 ^{3/8}	10 ^{5/8}
BACK HIPLINE (7" below waistline) (includes an ease of 1/4")	9 ^{1/8}	9 ^{3/8}	9 ^{5/8}	9 ^{7/8}	10 ^{1/8}	10 ^{3/8}	10 ^{5/8}
CAP HEIGHT	6	6	6	6	6 ^{1/8}	6 ^{1/8}	6 ^{1/8}
SHORT SLEEVE LENGTH	9	9 ^{1/4}	9 ^{1/2}	9 ^{3/4}	10	10 ^{1/2}	10 ^{3/4}
SLEEVE LENGTH	23	23 ^{1/2}	24	24 ^{1/2}	24 ^{1/2}	25	25

2.2.3 Sizes and Measurement

After learning how to measure a body and dress form, the next question that comes to mind is what is the size of an individual or dress form based on the measurements and secondly what size of the garment should be made that would fit the person properly.

A general sizing system for clothing production for a region or country is based ideally on the body measurements taken on a cross section of the population.

In earlier times everyone went to a tailor to get clothes made to ones own measurements. It is in modern times due to changing economy, society and the world, that there is growing demand for 'ready to wear apparel or RTW, which has made sizes and sizing systems very important.

Sizing systems are generally developed by the Government or standardization organizations that need to work out the standard sizes for the country. A large cross section of the population is measured to establish the standardized sizing system for the country. For example it is British standards with BS3666, which has established the sizing system for the British clothing Industry. All the shops selling garments or manufacturers for clothes for the UK market adhere to the BS3666. The size is suffixed with S or T denotes whether for a short or tall person. The buyer in UK can easily buy clothes of their size if one is sure of which size would fit, as generally all the garments in that particular size would fit the person.

Women have different sizes and shapes and the sizes are so varied that the extent of two women with equal hip girth can have a difference of as much as 12" in their bust measurement. On the other hand, two women of equal bust girth can be completely shaped differently. Most of the sizing systems are based on bust measurements for women.

A good sizing system incorporates the variation in figure shapes to be able to meet the requirement of the population of the country.

Apart from the bust and hip girth variation another factor that influences sizes is height. Most small manufacturers tend to ignore the difference in height and produce garments



for above average height women so that most of the shorter women can reduce the length as desired.

The country that has maximum size variation available in the market is United States. The number of the sizes in a sizing system depends on the body structure of the population. In country like India and US the body types of people in various parts (in India) and different ethnic groups (in US) is so varied that the number of sized in sizing system need to be much more than three usual ones - small (S), Medium (M) and Large (L). Some countries work with Extra Small (XS) and Extra Large (XL) and sometimes even XXL. In United States the womenswear sizes are numerical like 2, 4, 6, 8,10,12,14,16,18, 20, 22, 24, 26 etc. Apart from these sizes being available in the market there is 'Misses' and 'Petite' which cater to the medium and shorter women while 'Tall and Big' cater to taller and bigger sizes.

In India currently there is no single standard measurement chart available. Several organizations have been trying to work out the sizing and measurements. Individual companies or businesses work out their own set of measurement charts based on their customers or on the demand of the stores where they sell their products. This sometimes leads to confusion among customers as to what size to buy.

EASE

Ease or tolerance in a pattern means acceptable margin but there is a difference of 'ease of pattern' and 'ease of comfort'. Each garment is made for a purpose, an outerwear needs more allowance as it is to be worn over other garments where as a foundation or inner garment like a bra needs to be fitted like a second skin over the body. Ease added in a pattern for both these garments would vary greatly.

The size that one belongs to depends on the bust and hip measurement. Someone with abnormally large hip or bust in comparison to the other would need to pick up a size that accommodates larger measurement and would have to alter the garment in the other part. For example a women with 36" bust and 48" hip would need to buy either a size which fits 48" hip or may select A-line, flared or tent silhouettes which accommodate the girth of the hip.

Activity

Visit the market and check various womenswear brands what are the different sizes you can identify. Try out garments in different styles and brands do you fit into same size of different brands or is there a difference.

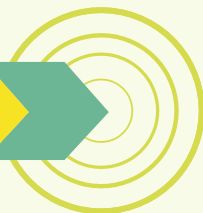



Visit the market and check various womens wear brands. Check the following:

- i. What are the different sizes you can identify.
- ii. Try out garments in different styles and brands. Does the same size of different brands/labels fit the same way or is there a difference?

Fill in the blanks

- a. Standard measurements are _____ in a _____ chart.
- b. Country that has the most elaborate _____ is _____.
- c. Sizing systems are _____ by the _____ or standardization organization for a country.
- d. The standard sizes for the country are established by _____ a _____ cross section of the _____.
- e. In UK sizing system was established by _____ for the _____ Industry.
- f. All garments manufacturers in UK market adhere to the _____.
- g. The size is suffixed with S to denote _____ and T for a _____ person.
- h. Countries have different sizes and _____.
- I. Two women with _____ hip girth can have a difference of _____ in their bust measurement.
- j. Generally _____ systems are based on _____ measurements for women.

Review Questions

1. What is a General Sizing System?
2. Who is responsible for developing the Sizing System?

2.3 TOOLS

2.3.1 Basic Equipment Required

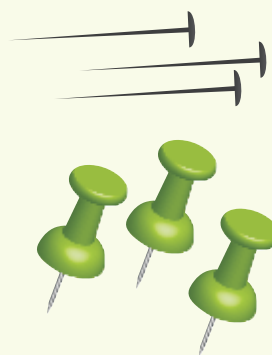

All pines to pine fabric pieces together

Pin Cushion or Pin holder to keep needles and pins in place.

Push pins to hold paper in place.

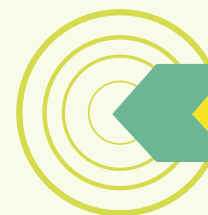



FASHION STUDIES

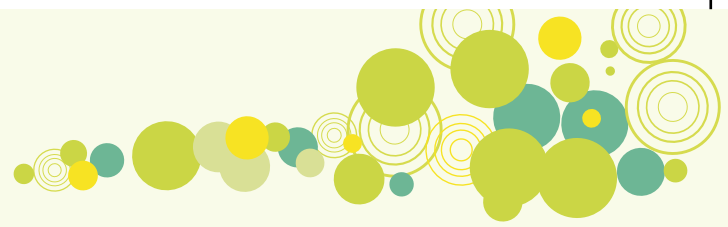

Scissors - large for fabric, another for paper and a small for clipping threads.



Seam ripper for opening any seams or stitches.



Grating scale to mark lines.

Measuring Tape for taking measurements



Pencil, eraser, pencil sharpener, plastic ruler

Pinking shears for finishing the raw edges of fabric.



Papers - plain paper, tracing paper, brown paper, graph paper.

Masking tape to keep fabric in place.

Plastic sheet for making templates.

Permanent pen to write on the templates



Coloured pencils to make rough layouts



Bot to keep things

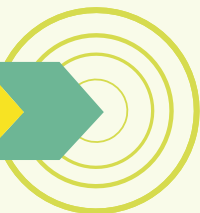



Steam iron to iron out wrinkles.



Awl to make holes in paper

Cutter for cutting paper



Tailors chalk for marking on fabric

Tracing paper for tracing



Tracing wheel for transferring the markings

Notcher to mark a paper



Styling tape for marking on dress form

Activity

Visit the school library and refer to books on pattern making.

- + See the different kinds of pattern making tools you can identify.
- + Try to find the tools on internet also.
- + In your scrap book state uses of various tools

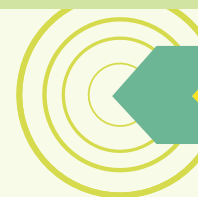

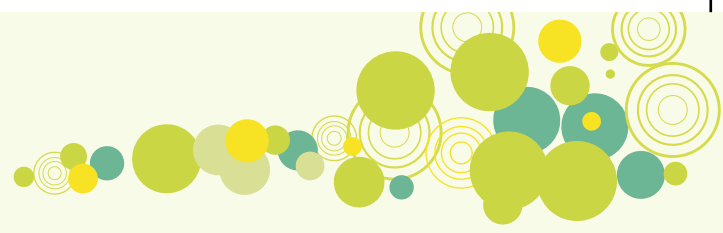

Fill in the blanks

- Grading ruler is used for drawing _____ & _____ in making a pattern.
- The _____ curve is used for drawing the _____ seam in a pattern.
- _____ is used for marking a seam line on a pattern.
- The pattern is made on _____ paper and test fitted on _____.
- _____ is used for marking notches on _____.

Review Questions

- Explain the use of French Curve as a Patternmaking tool
- Explain the use of Tracing Wheel as a Patternmaking tool

2.4 Fit

2.4.1 Garment Fitting

Apparel fit is the relationship between the size and contour of garment and those of the human body. A well fitted garment is a garment that hangs smoothly and evenly on the body, with no pulls or distortion of the fabric, straight seams, pleasing proportions, no gaping, no constriction of the body and adequate ease for movement. Hems are parallel to the floor unless otherwise intended, and the garment armhole and crotch seam do not constrict the body. It can be defined as a simple matter of length and width in each part of the pattern is correct for the human figure.

Fit refers to how well a garment conforms to the three-dimensional human body. Good fit is crucial to customer satisfaction. However, it is often easier to find clothes in the right colours, prices and style that one likes, than a well-fitted garment. The effect of a stunning design, gorgeous fabric and exquisite workmanship are minimized if the finished garment does not fit well on the intended wearer. Fit problems may be caused due to careless design, construction or may be the result of characteristics of an individual's body. No two bodies are alike, and sometimes even the left and right halves of the same body are not mirror images of each other.

New technology promises to overcome these problems; a new computer system can optically measure an individual's body in three dimensions. This data is then converted to a computerized, individual pattern, a man's suit designed by this method is ready to be cut out and ready to sew within 7 minutes of receipt of the measurement data. The resultant garments fit accurately as the computerized scanner detects subtle nuances in the shape of the body that normal measurement systems are unable to read. These

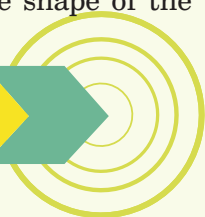



systems are on the stage of trial; but they would be costly and would take a long time to be readily available.

There are varying opinions on what comprises a good fit. Personal preferences regarding fit are governed by current fashion trends, cultural influences, age, sex, figure type, and lifestyle. The intended end use of the garment also affects the desired fit. For example, a person needs more ease for active sportswear than for spectator sportswear like in a tracksuit.

The relation between the size charts and body dimensions is not constant because of the changes that occur in the human population. Recent body surveys in UK, US, China, Germany and other countries proved that a garment sizing system for a certain body type does not cover more than the 25 per cent of the population for which it is addressed. Correct sizing is a prerequisite to good fit and customer satisfaction. Fit is a function of sizing and it affects comfort, durability of a garment. Sizing is often over looked as an important issue

Elements of Fit: The evaluation of Fit is based on five classical elements:

Grain: For a good fit the garment should be cut on the right grain or in other words on grain. An on grain garment hangs evenly and appears symmetrical. If the garment is off-grain, it will not hang straight. The garment and seam lines may twist or hang crooked because the fabric on each half of the garment behaves differently. Deviation in the grain line is a result of wrong cutting or stitching or even due to a poor posture of the wearer or figure irregularities that may interfere with the grain of the garment as it hangs on the body.

Set: This refers to a smooth fit without any undesirable wrinkles. Wrinkles caused by poor set cannot be ironed out, but result from the way the garment fits the wearer. Set wrinkles usually occur because the garment is too large or too small for the wearer and the garment hangs or sags when worn.

Line: This refers to the alignment of the structural lines of the garment with the natural lines of the body. Side seams of the garment should hang like a plumb line down the centre of the side of the body. It should be perpendicular to the floor. Centre front and centre back likewise should fall centre of the front and back of the body and be perpendicular to the floor. Darts and seams such as shoulder seams should visually appear to be straight lines that follow the body part they are intended to fit. Other seam lines should be gradually curving lines like necklines, waistlines, hiplines and armholes. Poor design or construction can result in an out of line garment. Even figure irregularities can distort the lines of the garment.



Balance: This occurs when the garment is in equilibrium. The right and left side of the garment appear evenly balanced or symmetrical, when viewed from front, back or side of the garment. A skirt is balanced if the legs of the wearer are in the centre and are not touching the front or back of the skirt. Balance relates to grain and line in the garment. A garment is out of balance when it is cut off grain, causing it to hang unevenly. Also if the line of the garment does not follow the line of the body, it will hang out of balance. Poor posture or lack of symmetry in the wearer's body is another likely cause of it.

Ease: This refers to the amount of roominess in a garment. Ease is the difference between the measurements of the body of the intended wearer and the measurements of the garment. There are two kinds of ease:

- + Fitting ease
- + Design ease

Fit ease is in direct contact with the body and is responsible for the comfort factor and design ease of the garment is for aesthetic appearance. A garment must contain adequate ease beyond the actual measurements of the wearer, to allow room for ordinary movements like walking, sitting, reaching out and even breathing. Ease in this context is called Fitting ease. Design ease is the extra style fullness added to the fitting ease. All the garments have fitting ease but design ease is optional as it is added purely for the sake of appearance and giving the garment its style.

2.4.2 Evaluating fit

In evaluating the fit of the garment, all the sides of the garment must be examined. The fitting should start from the top and move downwards. The analysis of fit is a complex process and remains a challenge, for both industry and customers. Apparel fit is a complex issue but of great importance for judging perfect clothing appearance, and the various technologies used, such as a 3D simulated form, may lead to more efficient decision making in the process of product development and quality control.

The following body parts should appear as:

Shoulders: The shoulders should appear smooth and feel comfortable. Seam should lie on top of the shoulder. In regular styles the arm-scye seam should fall on edge of the wearers shoulder. The shoulders of the garment should be wide enough so that the sleeves hang smoothly. If the shoulders are too narrow, the sleeves will pull across the upper arm and cause wrinkles. If fashion trends require the shoulders to be narrow or wider the pattern still should allow sufficient movement. The shoulder slope of the garment should match the shoulder slope of the wearer.

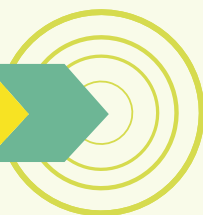



Bust/Chest: If the garment is too small, the seams or closures that are at the centre front or back are going to pull and gape open. A larger bust or highly developed chest often causes the button closure to gape open at centre front or back, also the garment may ride up because the larger bust curves takes up more length. A well-fitted dart always points towards the fullest part of the of the body curve it is intended to fit. The tip of the dart should end about an inch before the fullest part of the curve. Darts that are too short or darts that extend beyond the fullest part of the curve result in a bubble at the dart tip. Darts occurring anywhere in the garment follow the same principle. The practice of eliminating darts to speed construction creates diagonal wrinkles on the bodice front.

Neckline: Necklines should be large enough to fit without pulling or chafing but not so large that it doesn't lie flat against the body in front and back. The front of the basic neckline should always be lower than that of the back.

Collar: The most important factor in the fit of the collar is the neck circumference. The circumference of the collar should be at least 1/4th of an inch bigger than that of the neckline or just large enough for one to insert two fingers between the neck and collar. A properly fitted collar should be smooth and stays in place when the wearer moves. It should not be so tight that it pulls. A tight collar is uncomfortable and makes the neck look large. But neither should it be so loose that it gapes.

Arm-scye: The arm-scye must fit well for the garment to be comfortable and attractive. The circumference of the (arm-scye) should be large enough so they do not pull at the front and back of the garment, but not so large that it gapes. In a well-fitted arm-scye, the base of the (arm-scye) is cut close to the armpit, but not so close that it bites into the armpit. It should be cut about an inch below the armpit. This provides adequate comfort, room for movement, and close fit without wrinkles in the - area. If the arm-scyeaes too tight they are usually denote comfort and uncomfortable. Arm-scye in the front should be more deeply cut than at the back as most of the movements are in the front.

Sleeves: Well-fitting sleeves are attractive and comfortable. The circumference of the basic sleeve should be loose enough so that it does not bind nor has wrinkles horizontally around the arm. A tight sleeve apart from being uncomfortable makes normal arm movements impossible. Sleeves can be as loose as one wants but the only problem would be to wear the garment under a fitted jacket. A well-set jacket sleeve hangs with a slight angle towards the front. The crosswise grain at the bicep should lie parallel to the floor.

Waistline: Fit is essential for comfort. The waistline of the garment should not be so tight that it binds and rolls. It should have plenty of room for breathing and eating and it should return to its position after the arms are raised or lowered. It should not be so loose

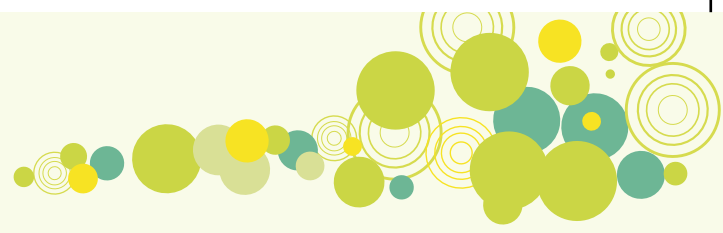

that it stands away from the body, droops, or adds bulk when a top or shirt is tucked in or worn under another garment. The narrowest part of the garment should fall at the wearer's waist. If there are buttons at the waist the garment should not pull or strain at the closure. A jacket should be big enough at the waist so that a person can sit even when it is buttoned.

Hips: The fit of the hip area is critical when fitting skirts or trousers. If there is adequate room in the hip area other parts of the garment can easily be altered to fit. Garments with enough room in the hip, thigh and abdomen area fit smoothly without pulling, wrinkling or riding up. Pocket, pleats or vents that open up indicate that garment is tight in the hip or abdomen area. If the garment has excess ease in hip or thigh area it will result in vertical folds.

Crotch/seat: Trousers and other bifurcated garments require a well-fitted crotch for comfort or durability. A properly fitted crotch does not cut or bind the wearer between the legs and conforms to the shape of the buttocks. There should be slight but not excessive ease in the crotch area. Crotch length generally has one inch of ease in the crotch area. The back of the crotch seam should be longer and more deeply curved than the front as the backside of the buttocks are more curved than the front. Bigger sizes require longer and deeper curved crotch lengths at the back. Diagonal wrinkles radiating from the crotch area are the result of, crotch curve not long enough to accommodate the size of the buttocks. Diagonal wrinkles in the front may also be due to the wearer's big abdomen. Wrinkles emanating upward from the crotch area indicate a too tight and high crotch, resulting in chafing and discomfort. Wrinkles emanating downwards from the crotch area indicate a low and loose crotch; it bags and sags, restricts walking and has increased probability of ripping from strain of movement. If the rise needs to be lengthened or shortened, the waistband should also be raised or lowered. Rise should not be lengthened or shortened in the crotch length as the same may lead to problems where none existed.

Another important **rule** of the fitting apart from knowing how to fit, is when not to fit. Clothes must not only fit but need to flatter as well. There is absolutely no need to fit a garment so close to the body that it looks too tight. The real expertise lies in the fact that one is able to strike a balance between the lines of the design and the lines of the figure. The ability to do this is a skill that one learns by training the eye to see and judge as to what flatters the body.

Fitting is like sculpturing it creates a three dimension form. Another question that is frequently asked is how many times one should fit. The answer to this is as many times as it takes to fit well.

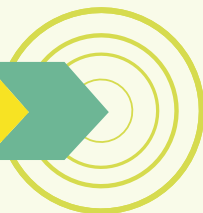



2.4.3 Need to fit

Mathematical calculations and pattern corrections alone cannot guarantee the fine fit of the garment. They can only provide an approximation of the needs of the figure. The other points to be considered are:

- + The style of the garment whether it suits oneself or not.
- + The necessary and sufficient ease in the garment.
- + The posture and the individual shape of the wearer.

These can truly be evaluated only on a fabric test fit, since only minor changes can be made once the garment has been cut on the fabric. Hence a test fit can save lot of wastage. There are times when test fit is not necessary, those are when one is sure of the style, knows from experience how to adjust the pattern, has sufficient material to re-cut if necessary and has sufficient seam allowances to borrow in emergencies. But if one has any doubts whatsoever, then test fitting is a must.

Commonly used test material is muslin, bleached or unbleached should be used in a similar weight to that of the final fabric. Any other solid coloured, plain weave fabric like poplin in a similar weight to final fabric would do. A plain surface is recommended as this clearly shows all seams, darts and other style details. Layout the pattern cut and mark your test fit fabric with equal amount of care as you would your final garment fabric.

Put the trial muslin together. The quickest way to get the effect of the finished garment without actual stitching is to overlap and pin all the seams lines. Pinning gives the same result and information, that one wants without going to the machine. It is so much faster and easier to unpin and then re-pin than to rip stitching and re-stitching.

Pins should be placed at right angle to the seam line, as in this method there is least amount of strain or pull on the seam, and it does not gape. While test-fitting trousers remember to baste stitch the crotch seam instead of pinning.

Check the test fit muslin and make corrections till completely satisfied. Mark all the corrections and the same should be transferred on the pattern for it is the paper pattern that one should use to cut the final fabric and not the test fit muslin. Mark new notches as the old ones may not hold good after the alterations. Check the lengths of two matching seams to ensure that the alterations have not created more problems, e.g. if you have corrected the dart intake of side seam dart in the front, check to ensure that both the side seams are still equal and if required make the necessary changes.



2.4.4 Methods of fit

There are two kinds of fitting:

One is the first **test fit** that is done on muslin at the time when the pattern is made. A basic test fit is done to check the pattern fitting; the pattern is cut with relevant seam allowances and pinned in place for test fitting. Make sure that seams and darts are in place. This fitting is always done from the right side of the garment, as it is easier to make changes and corrections. These corrections become the new seam lines for the garment. Check the garment for ease and fullness. It is important to mark buttons and buttonholes at right places in this fit.

The second is after the garment has been stitched **before final finishing**. Stitch the garment with relevant interfacing/ or underlining in place. Press it well and test fit to check the position of darts, seams, puckers if any and locate the position of outer seams. This type of fitting refines and perfects the fit of the garment.

Other times when **refitting** becomes necessary are if the garment has been purchased readymade from the market. Some alterations may be required for it to be fitted to an individual's size. If there are changes in the body size, for instance if some one has grown thin or has put on weight or if a child has gained height, refitting may become necessary. The methods by which each pattern seam or area is to be corrected and altered depends on the type of problems and nature of the fitting defect.

Activity - 1

Check your own wardrobe. What are the various fit issues you can identify? Try out garments and see if you can identify methods of correcting fit.

Activity - 2

Fill in the blanks

- Fitting is like _____ it creates a _____ form.
- Five elements of fit are _____, _____, _____, _____ & _____.
- Ease is of _____ kinds, i.e. _____ & _____ ease.
- _____ occurs when _____ is in equilibrium.
- The garment is called _____ grain if it is not cut on the _____ grain of the fabric and it would not _____ well.
- The side seam of the garment should _____ straight on the _____ of the _____.

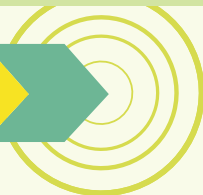



- g. There are _____ methods of evaluating the _____ of the garment.
- h. Pins should be placed _____ to the _____ line, as there is _____ of strain or pull on the _____.
- I. Check the _____ muslin and make corrections till _____ satisfied, _____ all the _____ corrections and _____ on the pattern.
- j. _____ pulls in a garment indicate that the garment is _____ and _____ folds indicate that it is _____.

Review Questions

1. Define Fit and identify elements of Fit
2. Differentiate between Test Fit and Garment Fit.

2.5 Pattern Development

2.5.1 Basic Bodice

To develop pattern for basic Bodice for women wear use measurements from the given chart or measure a dress form or a body. Take a paper, whose length is centre front length plus 3" and width is half of the bust width plus 4". Fold the paper lengthwise and with fold on the left hand side (away from you) mark a guideline 1" down from the top edge, mark A as illustrated.

A to B = front length

A to C = B to D = front width (+1/2" ease to be added if measured on dress form/body)

Join C to D

Mark D to E = centre front length

CE is front neck depth.

For neck width mark

CF = CE-1/8"

Square out lines from E & F.

Draw the neckline curves illustrated, using a French curve.

G = mid point of DE

GH = apex measurement



Square a line from H to I

- Mark DJ = Centre front to princess line measurement
- I K = I J, Join J and K to H
- KL = Front waist line measurement minus DJ
(+1/8"ease to be added if measured on dress form/body)
- LM = under arm seam length where M is on the fold line. Join as illustrated
- M to M1 = M1 to M2 = 2 1/2" square out for guideline, as illustrated
- B to N = Shoulder to waistline measurement
(+3/4"ease to be added if measured on dress form/body) where N is on the fold line.
- N to N1 = 1/2"

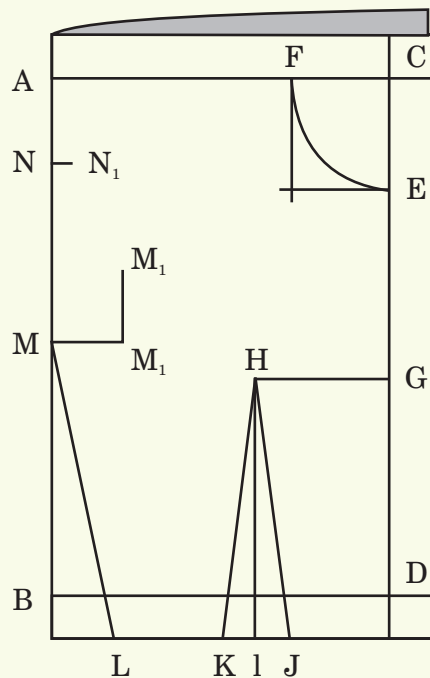

Draw the front armhole curve as illustrated

Join F to N1

Mark F to F1 and N1 to O = 1/2 shoulder measurement





Join F1 to H and O to H.

Trace BD line, L M line and M M1 line on the other half of the paper.

Extend M M1 line on the second half of the paper.

Mark B to Z = Back width (+1/2"ease to be added if measured on dress form/body)

Z to Y = Centre Back Length

Y to X = C F

X to W = 7/8", draw the back neck line curve as illustrated.

Measures Z to L1 and from this measurement subtract back waistline measurement (+1/8"ease to be added if measured on dress form/body).The difference is dart intake at U.

Z to U = Centre back to princess line measurement.

Mark U to V = Dart intake, T is mid point of U and V

Square out from T to S, Join S to U and V.

Mark Y R = 1/4 Centre back length

R Q = Back shoulder blade measurement.

QQ1 = Draw 1" guideline, as illustrated.

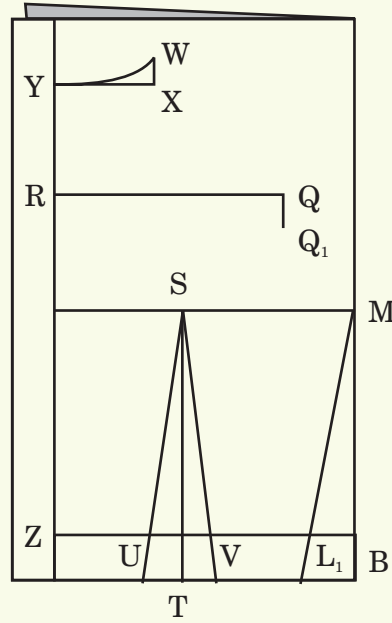

Join W to N1 in front

W to P = $\frac{1}{2}$ shoulder + $\frac{1}{8}$ "

P to P1 = $\frac{3}{4}$ "

P1 to P2 = W to P ($\frac{1}{2}$ shoulder + $\frac{1}{8}$ ")

Joint P to S.

Join P1 to P3 such that P3 is 1" above the shoulder blade line (RQ).

Draw the armhole as illustrated.

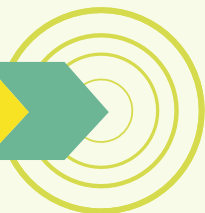
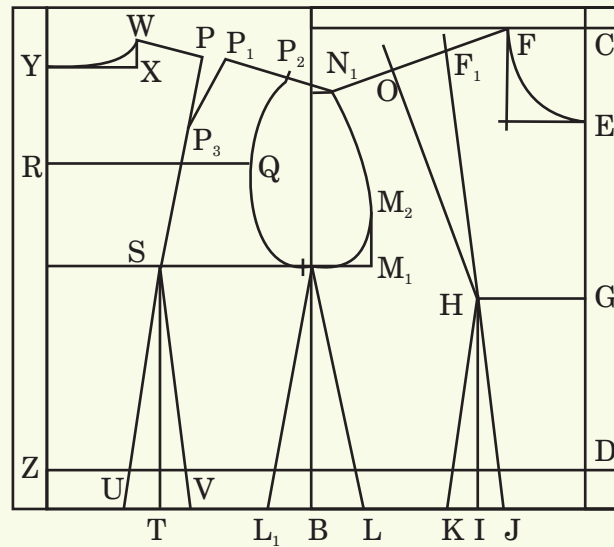



Truing or correcting the lines or darts to conform to body shape or aligning the dart legs and seams.

Front shoulder

Fold the shoulder dart at the apex, matching the two dart legs keeping the folded edge towards the neckline. Join the neck edge with the armhole edge with the straight line at the dart ends. Use a tracing wheel to trace out the folded edge.

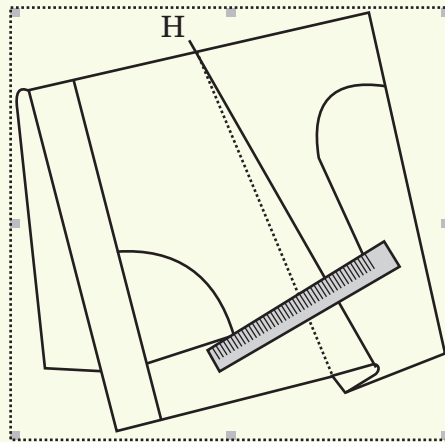

Back shoulder

Fold the shoulder dart matching the two dart legs keeping the folded edge towards the neckline. Draw the shoulder line with the help of the French curve as illustrated, dropping 1/8" on the armhole edge.

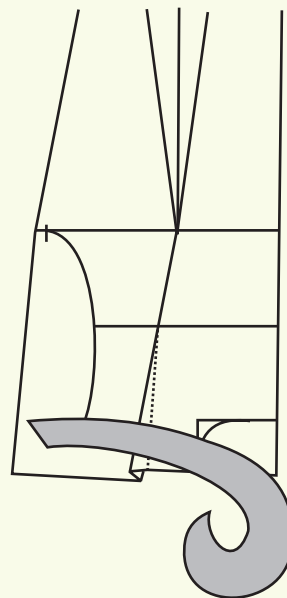



Waist line

Fold both the waist line darts (by matching the dart legs) and also close the side seam, keeping the pattern folded at the apex line. True the waist with help of a french curve, blending the waist line darts and side seam. The side seam should be dropped $\frac{1}{4}$ " at the side seam, as illustrated.

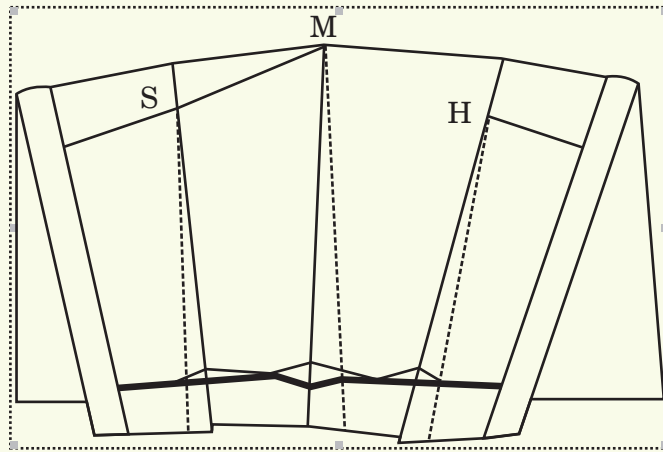

2.5.2 Sleeveless bodice

For a sleeveless bodice trace the basic bodice block is used. Change the armhole as follows:

Go up $\frac{1}{2}$ " on the armhole level i.e. E and F and redraw the curves, as illustrated.

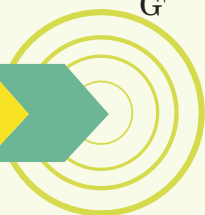
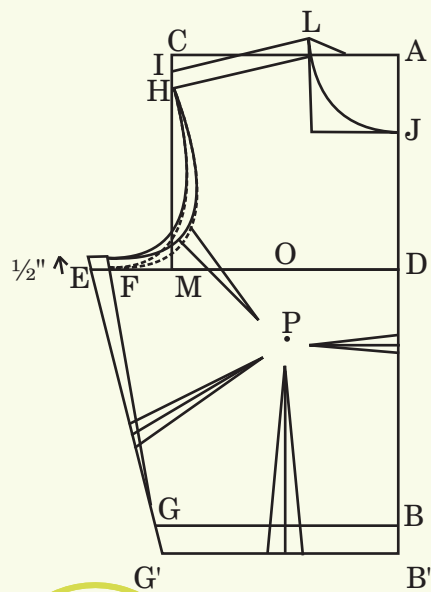



Activity

Collect pictures of garments which have been made using a basic bodice block. How many have two darts and how many are without any dart? Maintain this information in your scrap book.

Fill in the blanks

- The waist of the bodice is _____ by closing _____ darts and then a _____ is drawn using a French curve.
- The back shoulder line is drawn with help of _____ by dropping _____ on the _____ line.
- The apex is marked at _____ of _____.
- Waist dart at the back is calculated by _____ the _____ measurement from _____.
- Front waist dart is obtained by _____ out a line from _____ to _____ and the distance between this point and center front to _____ is half of the dart.
- For sleeveless garment go $\frac{1}{2}$ " _____ on the _____ level.

2.6 Neckline

2.6.1 Neckline & its variations

There are number of variation in necklines that are possible to make once the basic block has been drafted.

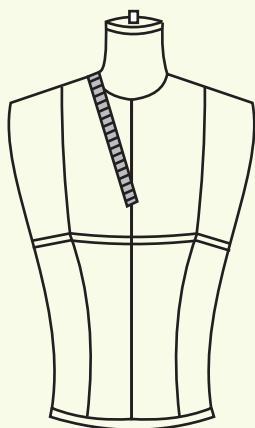

Neckline measurement A

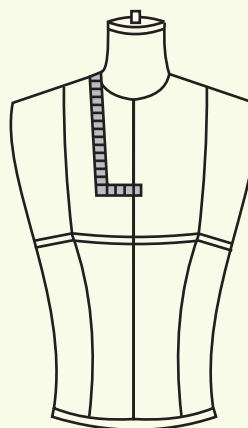

Neckline measurement B

The **measurement** required for any neckline is the depth of the neck measured from the nape of the neck point to the center front diagonally. (Neckline measurement A)



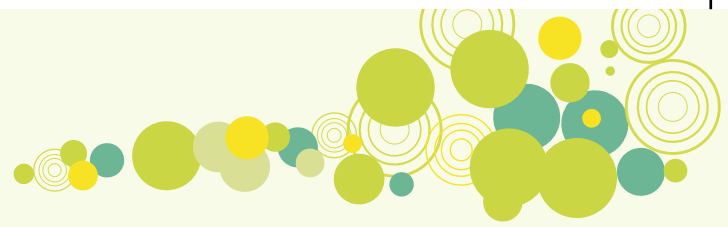

In case of necklines like square, glass neck, sweet heart measure in a straight line on the body for the length and for the width of the neckline at that point to the center front is also measured. (Neckline measurement B)

Points to be kept in mind for Necklines

1. If a neckline is made wider in the front, the same needs to be done for the back.
2. Try avoiding deeper neckline for both front and back at the same time. In case one decides to keep the neckline deeper in both front and back then an ease of about $\frac{1}{2}$ " needs to be taken out on the centre front neck.
3. The measurement which is taken diagonally should be marked diagonally on the pattern and a measurement taken straight should be marked straight.
4. For curved neckline, always square out $\frac{1}{4}$ " either side at center back and center front and on shoulder level.



V-Neck



Broad V



Round



U



Square



Glass



Sweet Heart



Sweet Heart Variation

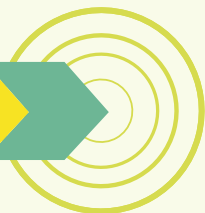



V-Neckline

Trace the neckline of bodice block with dotted line as illustrated.

Extend the centre front line up to A.

From point A square out lines so that they touch the shoulder and neckline intersection at B.

From B, mark $BC = 7''$ down or as required diagonally.

BC is the new V neckline join with a slight curve.

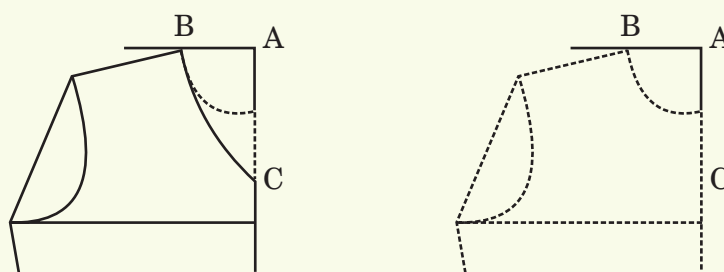

Broad V-Neckline

In case, one needs a wider neckline mark $BB' = 1''$ or as desired and join B'C for front neck with a slight curve.

If you want a deeper neck at the back mark $BB' = 1$ or as desired and draw B'C' as the new back neck.

The neckline can be finished with either piping or facing.

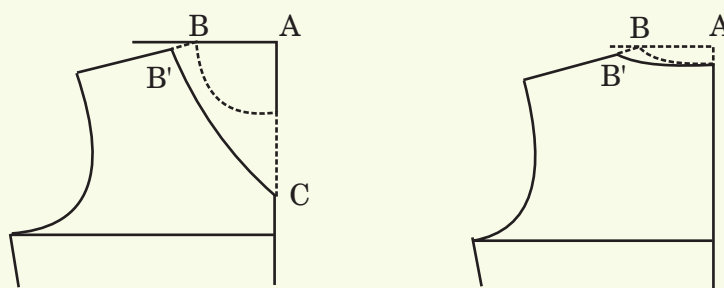

U-Neckline

Trace the neckline of bodice block with dotted line as illustrated.

Mark the points AB as for V neckline.

From B measure diagonally down for the neck depth at centre front as required and mark it as C.

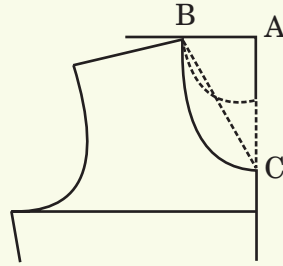

From point C square out $\frac{1}{4}$ ".

From point B square down $\frac{1}{4}$ ". Join BC for a U neck as illustrated.

Finish the neckline as desired.

Round Neckline

Round neck is a variation of U neck. It is cut wider at the shoulder and deeper at the back.

Trace the front or back neck of the bodice as illustrated.

Mark the points AB as for V neckline.

For the front neckline, from B measure the neck depth as required and mark it as C.

From point B go out 2" or as desired to B'.

For the back neckline, from A mark C as desired for the neck depth. B B' is same as front.

Square $\frac{1}{4}$ " down from B' and square $\frac{1}{4}$ " in from C.

Join B'C for the round back and front neckline as illustrated. Finish the neckline as desired.

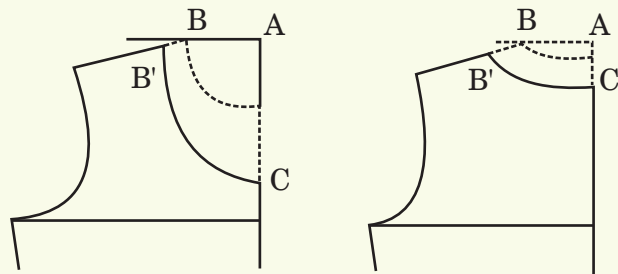

Square Neckline

Trace the neckline of bodice block with dotted line as illustrated.

Mark the points AB as for V neckline.

Square down from B to D as the side depth of the neck required or $5\frac{1}{2}$ ". Square out from D to C on the center front.

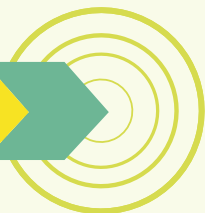



This is a basic square neck.

Finish the neckline as desired.

The neck can be widened as in the round neck.

If one feels that neckline is too wide, reduce CD as shown.

CD should be taken as $\frac{1}{2}$ of the neckline width desired.

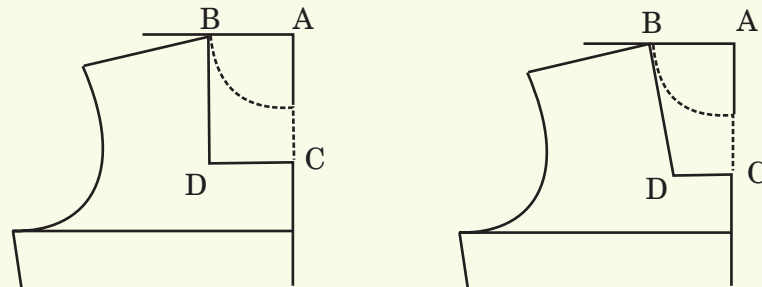

Glass Neckline

Trace the neckline of bodice block with dotted line as illustrated.

Mark the points AB as for V neckline.

Square out 1" or as desired from C to D.

Join BD and DC with a straight line for the Glass neckline.

Finish the neckline as desired.

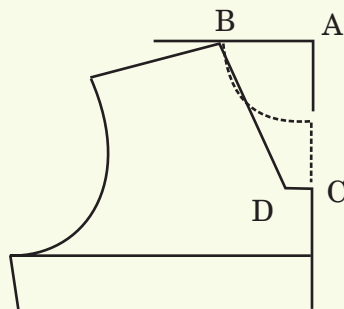

Sweet Heart Neckline

Trace the neckline of bodice block with dotted line as illustrated.

Mark the points AB as for V neckline.

From point B square down to D for the side depth of the neck required or 5".

Mark E on centre front, where CE = $3\frac{1}{2}$ " or as desired.

Join BD and DE with straight lines, for basic sweet heart neck.



Variation of Sweet Heart Neckline

Square a line at D about 1" on either side as shown.

Join BD' and D'E with curved lines for a curved variation.

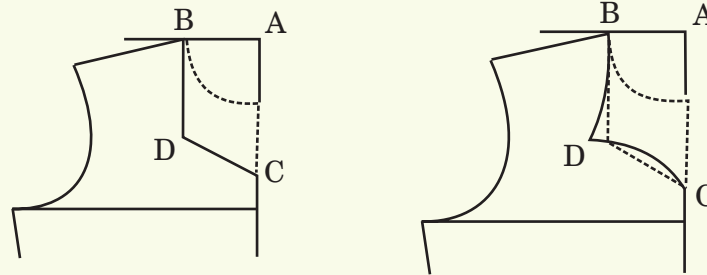

2.6.2 Finishing of neckline

Piping is a bias strip of fabric $1\frac{1}{4}$ " wide and is attached to the neckline on the seam line after stretching. The piping is finished either by hemming or machine stitch. It is finished to about $\frac{1}{8}$ " - $\frac{1}{4}$ " wide ready on the right side of the garment. It is a popular finish for blouses and other Indian garments.

Facings are of two kinds - bias facing and shaped facing.

Bias facing is a similar strip of fabric like piping but is attached to the neckline without stretching. The same is finished completely on the wrong side.

Shaped facing - A shaped facing is cut following the shape of the neckline and is attached on the right side and then is completely turned in. The width of this facing varies for each design but is generally $1\frac{1}{2}$ " wide.

Activity

Collect pictures of various necklines and maintain this information in your scrap book. Try making patterns of these necklines.

Activity

Draft a Sweetheart Neckline

Fill in the blanks

- To ensure that the neckline doesn't end in a point go out _____ on _____ of the bodice.
- While making a neckline deep in front it is _____ not to make the neckline _____ and _____ at back.

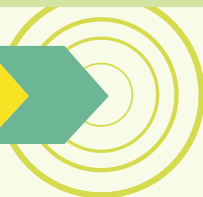



- c. A _____ neckline is drawn using a French curve.
- d. The _____ facing is cut keeping the pattern of the _____ of the desired piece.
- e. The measurement required for any neckline is the depth of the neck measured from the _____ of the _____ point to the center front of the _____.

Review Questions

- 1. What are the measurements required to draft a neckline?
- 2. What are the different necklines that can be finished with Bias Facing?

2.7 Dart Manipulation

2.7.1 Introduction

Dart manipulation is a useful and interesting tool for pattern maker for creating interesting, innovative dart placements and style lines. The change in the position of the darts creates interest in the garments in different dart positions. The same can be magnified by using similar technology on striped fabric where a dart gives a new dimension to the striped pattern. The darts can be stitched as new darts, as style lines, can be converted into tucks, pleats, gathers, yokes, etc. The basic fit of the garment is not altered by these manipulations.

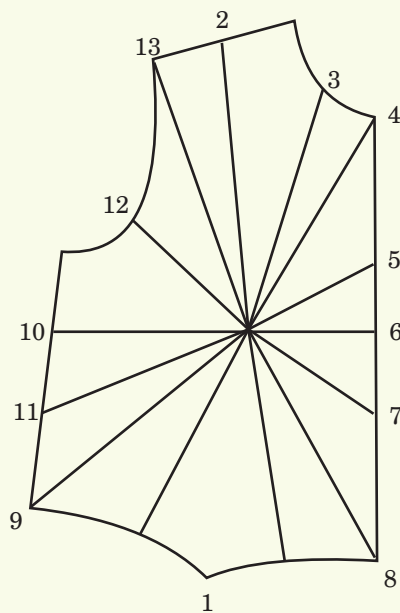

- 1. Waistline Dart
- 2. Shoulder Dart
- 3. Neck Dart
- 4. Neckline and C.F. Intersection C
- 5. C.F. Dart
- 6. C.F. Dart
- 7. C.F. Dart
- 8. C.F. Waistline intersection Dart
- 9. French Dart
- 10. Side Seam Dart
- 11. Side Seam Dart
- 12. Armhole Dart
- 13. Flange



There are two methods of dart manipulation

1. Pivot Method
2. Slash and spread method

Pivot Method

In the pivot method, the dart is pivoted on apex and dart is closed and pattern/sloper opens on new desired line, the pattern itself spreads on the new position, to create the new design.

2.7.2 Slash and Spread Method

In the slash and spread method, as the name implies the pattern/sloper is slashed or cut on the desired line and as the old dart or excess is closed, the pattern itself spreads on the new position, to create the new design. Some of the new dart positions are illustrated here.

Shoulder dart to waist

Take two dart basic block, slash the new dart position i.e. the waist dart. Fold and close the shoulder dart. Trace the new pattern on separate sheet.

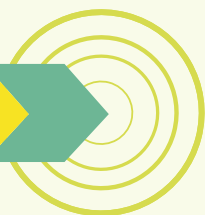
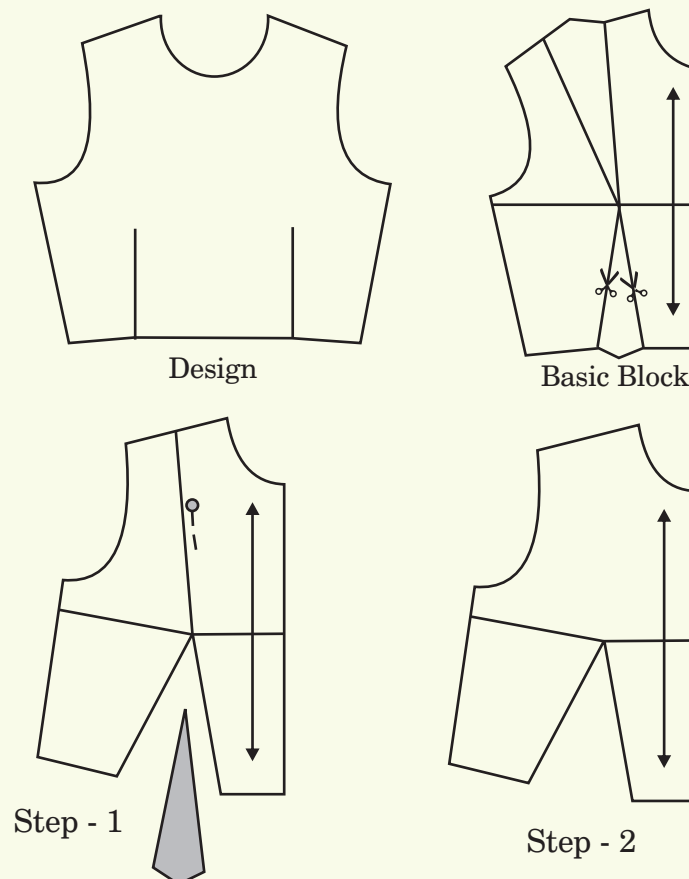



Waist dart to centre front

Take one dart bodice block. Slash the new dart position, close the old dart. Trace the pattern on separate sheet.

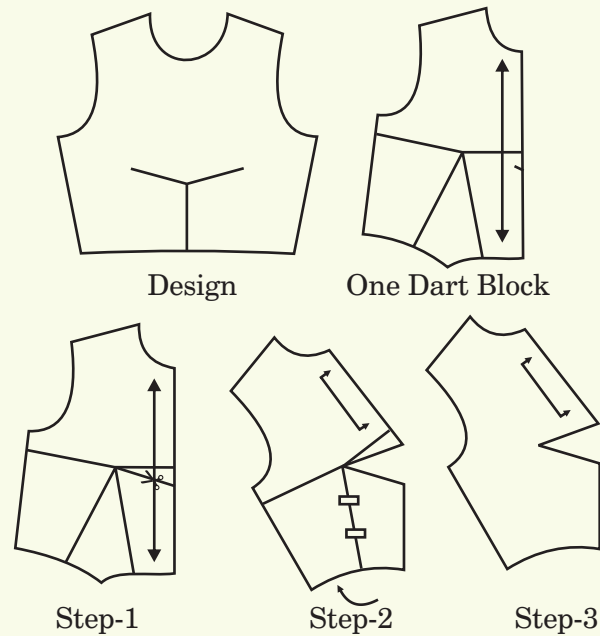

Shoulder dart to armhole side seam intersection

Take two darted basic bodice block. Slash the new dart position, close the old dart.

Trace the pattern on separate sheet. Shoulder dart to armhole side seam intersection?

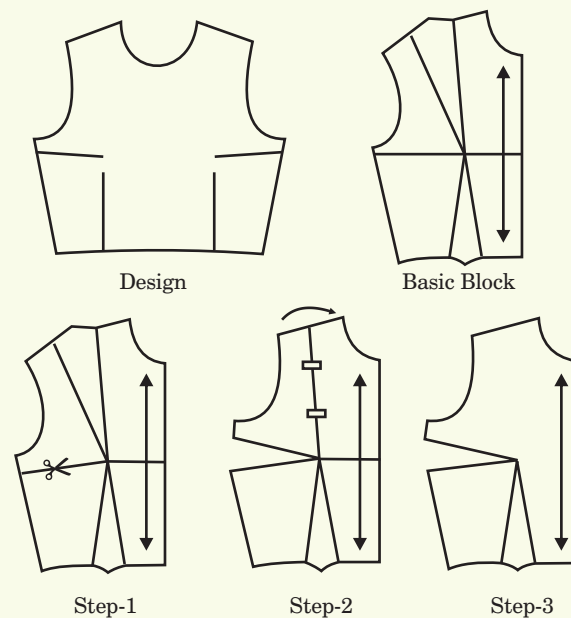



Darts into a Princess line

Take a one dart sloper. Shift the dart away from the princess line desired. Draw the princess line as required. Mark the notches and grainline on both the pieces as illustrated. Slash on the princess line and close the dart. Trace the patterns on another sheet of paper. Ensure that the notches are transferred on the final pattern.

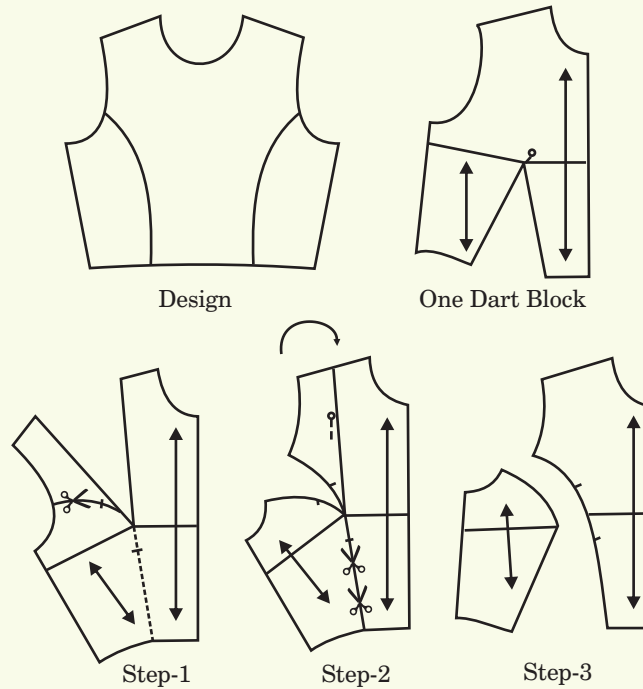

Activity

Fill in the blanks

- Dart manipulation is _____ for pattern maker to create _____ and _____ designs for _____.
- A Dart is named after the _____ it _____.
- A waist dart is a dart that starts from _____.
- Two methods of dart manipulation are _____ & _____.
- In this method the old dart is _____ and its suppression folded and the new dart position is _____ and opened.

Review Questions

- What is Dart Manipulation? Why is it important?
- What are the different methods of Dart Manipulation?

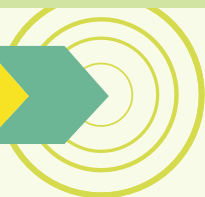



2.8 Skirt

2.8.1 Basic Skirt

To develop patterns for the basic skirt for women wear, use measurements from the given chart or measure a dress form or a body. Take a paper, whose length is the desired length of the skirt plus 3" and width is half of the hip plus 4".

Make a block A B C D E F, where

A to B = back hip (+1/4"ease to be added if measured on dress form/body)

B to C = front hip (+1/4"ease to be added if measured on dress form/body)

A to D and C to F = Desired length, e.g. 21".

A to G = C to H = 7", hip level

Joint G to H. Mark I at side seam

B to B1 and B to B2 = $\frac{3}{4}$ "

Mark I1, 2" above I.

Passing through B2 and B1, join I1 J and I1 K extending it $\frac{3}{8}$ " above the waistline, as illustrated using hip curve.

A to A1 = $\frac{1}{4}$ "

Join J to C, K to A1 as illustrated, using the hip curve ruler.

Measure J to C, K to A1 and note the measurement on paper, from this measurement subtract the front and back waistline measurement respectively. The difference is the dart intake for both front and back.

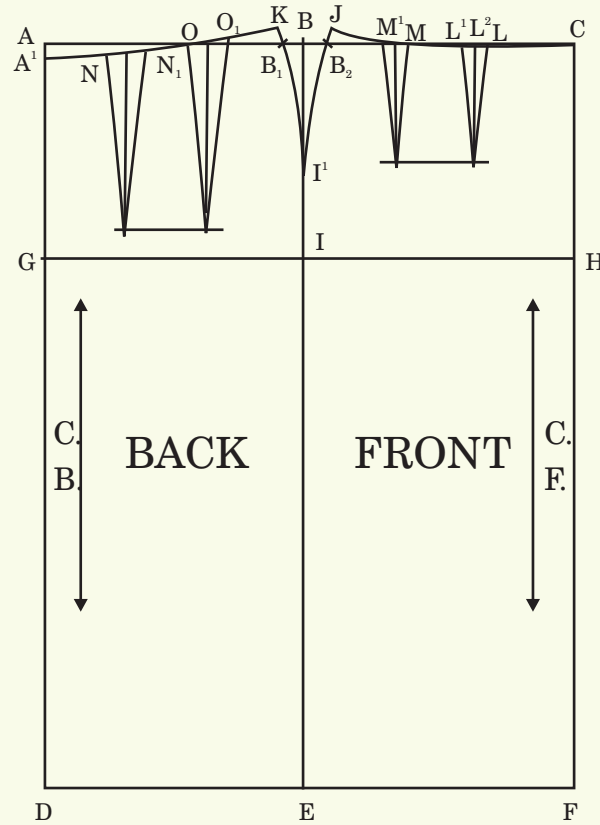

Divide this excess into two darts for both front and back.

Draw a guide line parallel to the waist line at a distance of $3\frac{1}{2}$ " for front and $5\frac{1}{2}$ " for the back,

Mark C to L = Centre front to princessline measurement

L to L1 = 1st dart ($\frac{1}{2}$ of the total dart intake for front)

L2 is midpoint of L, L1.

L1 to M = $1\frac{1}{2}$ "

MM1, = 2nd dart ($\frac{1}{2}$ of the total dart intake)

Mark A1 N = Centre back to princessline measurement

N to N1 = 1st dart ($\frac{1}{2}$ of the total dart intake for the back)

N1 O = $1\frac{1}{2}$ "

O to O1 = 2nd dart ($\frac{1}{2}$ of the total dart intake)

)Find the midpoint of all the darts and draw a perpendicular line till the guideline. Join these points to the dart point to form the dart legs.

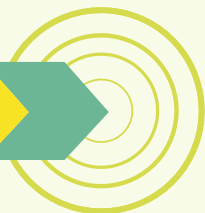



Trueing

Fold the dart at vanishing point and true the waistline as illustrated raising the waistline by $\frac{1}{4}$ " - $\frac{1}{2}$ " (when you true the waistline with the help of French curve it automatically goes up) at the side seams. Drop back waist line by $\frac{1}{8}$ " at centre back.

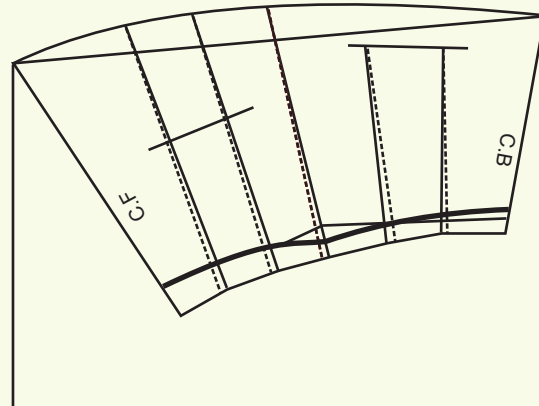

2.8.2 One dart basic skirt

Use a basic skirt sloper that has two darts. Measure the dart towards the side seam and add the measurement to the 1st dart i.e. towards the centre front or back and eliminate the 2nd dart. Note that the length of new waistline dart in the front is $5\frac{1}{2}$ " same as the back dart length. Find the mid point of the new dart and mark the centre and true the waistline. This method is called measurement method and can only be used in skirts/trousers, as there is no apex in lower half of the body.

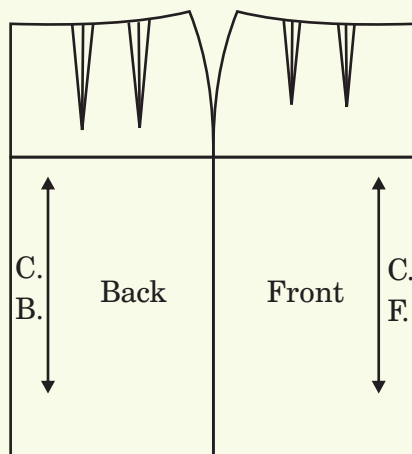

Fig.1

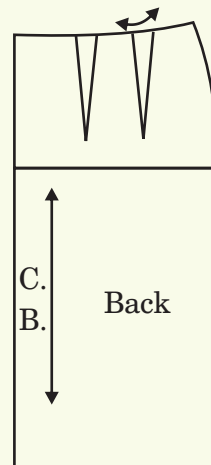

Fig.2 (a)

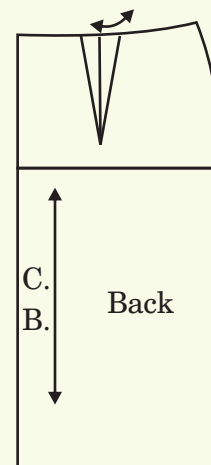

Fig.3 (a)

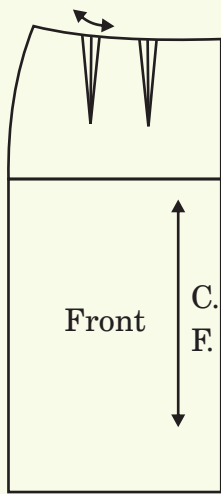
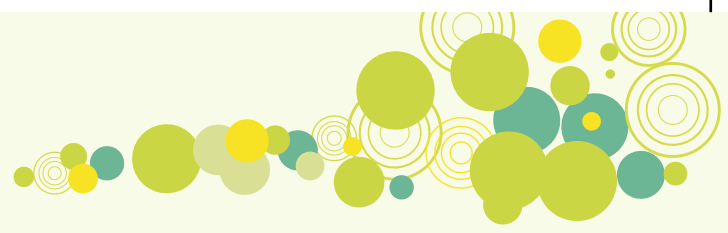

Fig. 2(b)

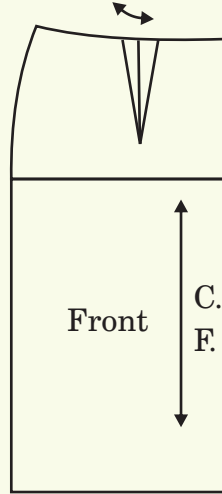

Fig. 3(b)

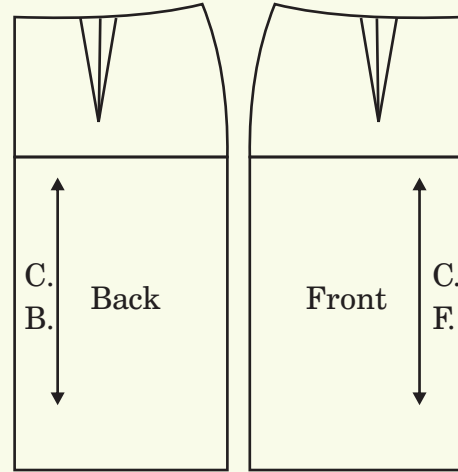

Fig. 4

One Dart Basic Skirt

2.8.3 A-Line skirt

Take a one dart skirt sloper, draw a slash line as illustrated (fig.2). Slash the line and close a part of the waist dart, so that the ease is shifted to the hem. Add 1" - 1 1/2" on the side seam at hem line for A-line shape in the skirt as illustrated. Blend till the hip level for both front and back and also blend the hem line.

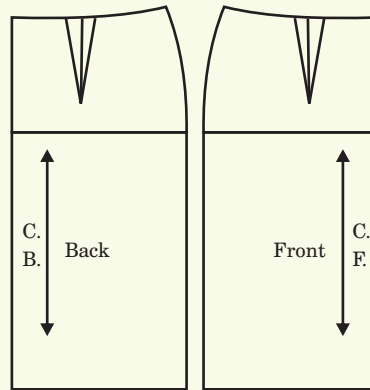

Fig. 1

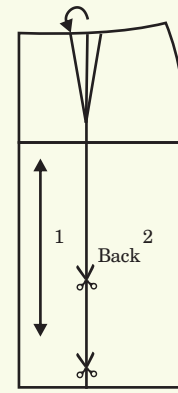

Fig. 2

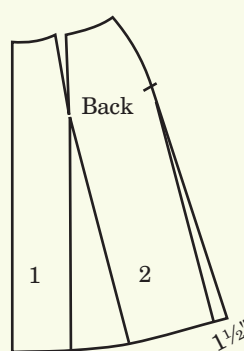

Fig. 3

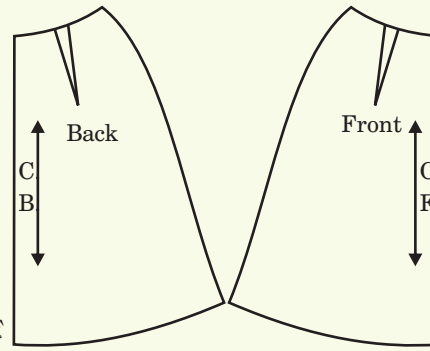
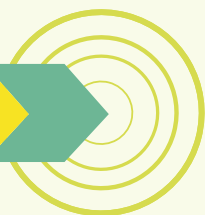

Fig. 4

A-Line Skirt





2.8.4 Flared skirt

Take a two dart basic skirt sloper, draw the slash lines as illustrated (fig. 2). Slash on the line and close the darts. Add 1½" -2" on the side seam blending the same at the hip level (fig. 3)

Balancing the hem

As the lengths and width of the front and back dart are different, the hem of the front and back skirt after closing the darts would also be different. Measure the difference between the two at the hem. Subtract half of the difference from the larger side and add half of the difference to the smaller side to match the hemlines, as an unbalanced hemline would make the skirt swing forward or backwards, towards the side that is smaller. This method is necessary for a professional pattern.

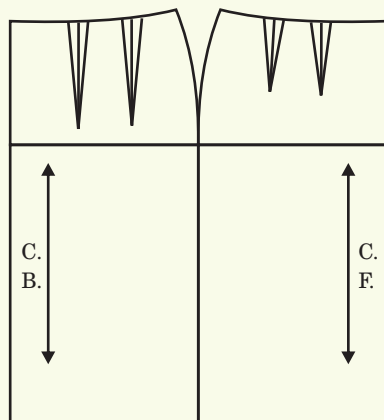

Fig. 1

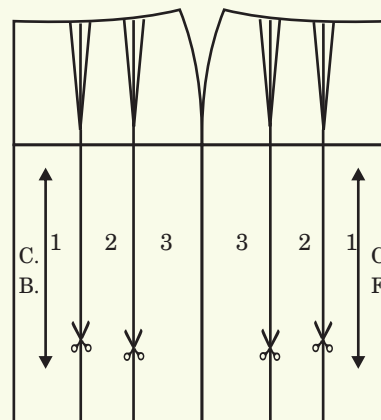

Fig. 2

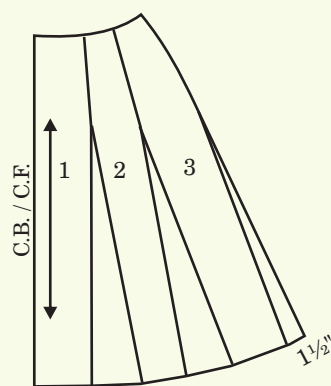

Fig. 3

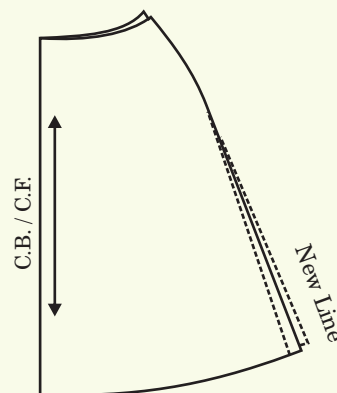

Fig. 4

Flared Skirt



Activity

Collect pictures of skirts with different hemlines and maintain this information in your scrap book.

Fill in the blanks

- Balancing the hem of a flared skirt is required due to _____ and _____ in the pattern.
- A-line skirt has _____ fullness added to the _____ of the skirt.
- A single dart skirt is made by combining the _____ of the _____ dart skirt.
- The length of the dart in the front in a single dart skirt pattern _____ is in a two dart skirt pattern is _____
- The difference in _____ of dart in a single and two dart skirts is because if a dart is _____ and bigger it will result in a _____ at the dart point.

Review Questions

- What is Balancing?
- How do you balance a skirt hemline?

2.9 Sleeve

2.9.1 Sleeve Block

To develop a pattern for a basic sleeve for women wear, use measurements from the given chart. Take a paper, whose length is the desired length of the sleeve plus 3" and width is half of the bicep plus 2" Fold it lengthwise and place there paper with its fold towards you.

Mark a guide line 1" away from the edge and label A.

A to B	=	Cap height
A to C	=	Full length
B to D	=	$\frac{1}{2}$ bicep circumference
B to E	=	$\frac{1}{2}$ BC-1 $\frac{1}{2}$ "
E to F	=	$\frac{1}{2}$ elbow circumference (that includes ease of $\frac{1}{2}$ " minimum)



Find the mid point of A to B by folding the paper and draw the line JK.

Find the mid point M of KL line and on M go in $\frac{1}{4}$ ". Redraw the front curve as illustrated.

Mark the notches

For front mark one notch = $\frac{1}{2}$ " below point K.

For back mark two notches, one at $\frac{1}{2}$ " below J and next $\frac{1}{2}$ " away from the first notch.

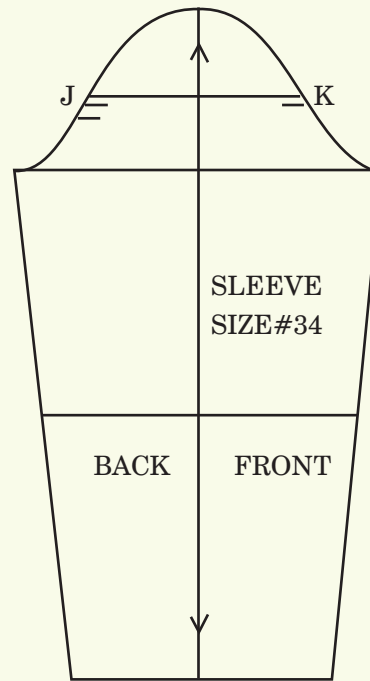

FINISHED PATTERN

Activity

Exercise

1. Collect pictures of sleeves and its variations and maintain this information in your scrap book. Try naming these sleeves.

2.10 Collar

2.10.1 Principles of Collar Development

The Collar is an added feature onto the neckline and it frames the face. It is one of the most important details of the garment as it draws maximum attention. There are three kinds of collars

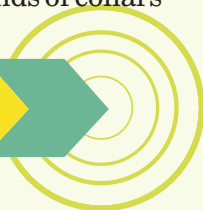



- + Stand collar
- + Flat collar
- + Roll collar

Stand collar

Stand collar stands around the neck, like Chinese or mandarin. These are cut after measuring the neck edge of the pattern.

Flat collar

Flat collar lies nearly flat on the shoulder, like Peter Pan and is cut by tracing around the neck edge of the basic bodice.

Roll collar

Roll collar is the variation of stand and fall collars where the collar stands around the neck and then rolls over to frame the face, like a turtle neck.

Collars are always cut double. The collar that comes on the top is called Top collar and the collar that comes under it is called Under collar. The Under collar is always cut smaller, instructions are given later in the chapter.

Terminology for collars

- + Neckline Edge - the edge of the collar that is stitched to the neckline.
- + Collar Edge - the outer edge of the collar also called leaf edge.
- + Collar Stand - the part of the collar that stands especially at the center back.
- + Roll Line - the line of the collar on which the collar folds or rolls.

2.10.2 Mandarin collar

Measurements needed:

Back neck - measure center back to shoulder at the neck edge.

Front neck - measure center front to shoulder at the neck edge.

A-B = 1½" is the collar stand

B-C = back neck

C-D = front neck

D-E = ½".





Draw a curved line from E to C

Square $1\frac{1}{2}$ " line at right angles to the curved line at E. Mark it as F.

Draw a line from A to F parallel to neck edge.

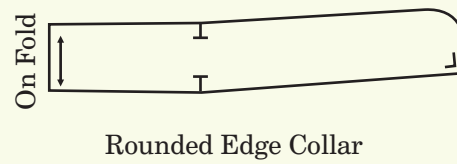
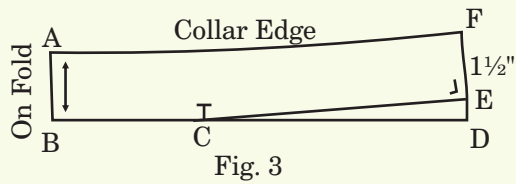
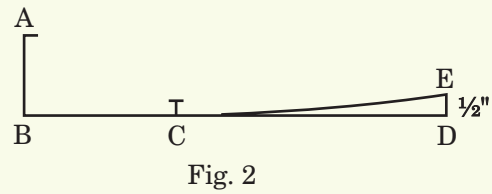
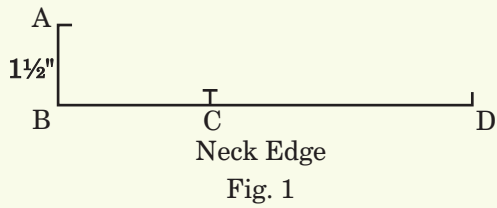

2.10.3 Peter Pan collar

Trace back pattern. Place front pattern on traced copy touching the neckline and overlapping the shoulder tips 2 inch for a roll of $\frac{1}{4}$ ".

This overlap can vary depending upon the roll desired. Lower the back and front neck by desired amount as illustrated

Redraw the neckline and copy again along with part of the center lines. A-B = desired collar width,

Draw a line starting from the centre back till centre front as shown in diagram. Shape the front as desired.

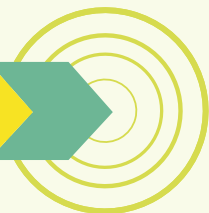
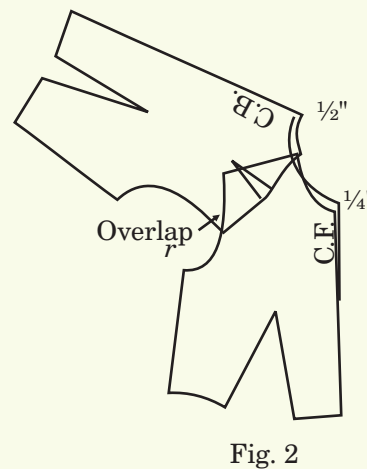
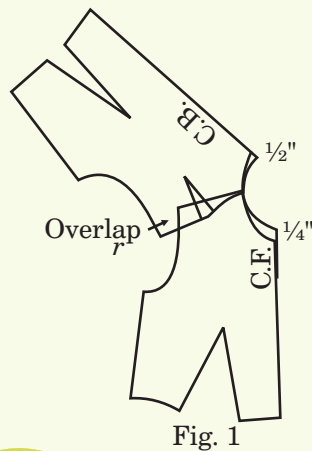

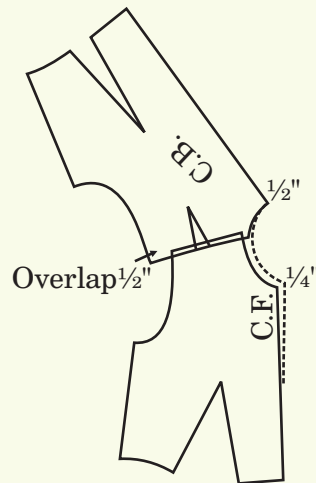

Fig. 1

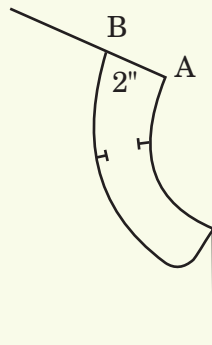

Fig.4

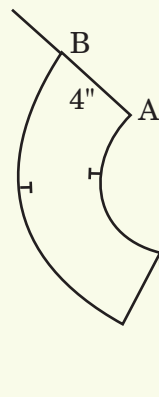

Fig.5

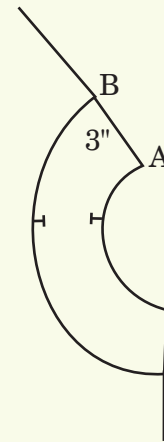

Fig.6

The above diagrams show various collar width and edges at centre front

Activity

Exercise:

1. Collect pictures of blouses and dresses with different collars and necklines and maintain this information in your scrap book. Try making patterns of at least five designs collars.

Fill in the blanks

- a. The cap height in a sleeve is required to draw the _____ of the sleeve.
- b. A Chinese collar _____ the neckline of the garment and usual width of the collar is _____.

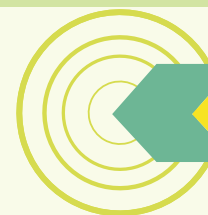



- c. Peter Pan collar _____ at the shoulder. This is achieved by overlapping _____ & _____ shoulder by at least _____.
- d. Outer edge of the collar is called _____ edge or _____ edge.

Review Questions

1. How is the Neckline Edge different from a Collar Edge?
2. Give an example each of Flat and Stand Collar.

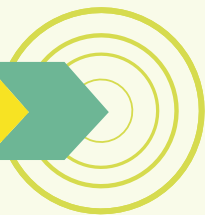



Chapter 3

3.1.1 Understanding Fashion - Definition and Overview

Fashion is an ever changing, vital and influential force that impacts our everyday lives. Our lifestyle i.e. - the way we live, what we eat, what we wear, and the activities we indulge in and how we spend our leisure time are all manifestations of this dynamic force.

Fashion hence reflects a society's prevailing customs; it's political, economic and cultural state at any given point of time.

Webster defines fashion as 'prevailing custom, usage or style'.*

However, fashion is much more than just the clothes and accessories. Fashion is also the spirit which goes into their creation, the money that is involved in promoting them and the people who wear the clothes.

In the past, fashion emerged from the courts and the royal patronage. In history, several cities have been, in turn fashion capital due to the cultural power that these cities exerted in that period of time; this includes Milan, Rome, Venice, London, Paris, Madrid, Barcelona, Vienna etc. However, it is the aura and allure of Paris that continues to draw international designers to the French capital to show their collection and to make a name. Thus France has sustained the image of the actual centre of fashion.

Fashion capital is hence a city which has the potential to be a major centre for fashion industry in which activities



Fig 1: Women and home magazine September 1959 issue; reflecting lifestyle of the time



Fig 2: Graduating Fashion Designers of NIFT serving in retail and export industry

*Webster's New Collegiate Dictionary, G.E.C Merriam Company, Springfield, Massachusetts, 1973, p. 416



of production, retailing of fashion goods, hosting of fashion events and fashion related trade fairs generating significant economic output, can be held.

A fashion capital in all its feasibility will have a strong subculture, capable of inspiring not only fashion professionals but also the citizens of the city. The principal 'big four' fashion capitals of the world are London, Milan, New York and Paris. However, wider connectivity of the world at the click of a button and the easy sharing of information has led to emerging of other major fashion centres around the globe, Like Tokyo, Shanghai, Mumbai, Toronto, Dubai, Düsseldorf etc.

Undisputedly fashion today is a colossal global business, employing millions of people in either fashion industry or fashion business.

Fashion producers fall into three basic categories: haute couture; ready-to-wear designer labels; and the mass-produced ready-to-wear industry.

The *haute couture* producers are the highly creative design houses that produce very expensive garments made to order for individual customers.

The *ready-to-wear* designer labels are known for products designed by their talented designers. Their fine quality, innovative styling is made in standardized sizes and usually manufactured in factories.

The *mass-produced, ready-to-wear garments* are manufactured off-shore, coming out of low wage countries at much lower costs. The primary objective is per piece production at a competitive price.

3.1.2 Haute Couture

Fashion leadership in customized. Fine dressmaking started with a small group of French fashion producers known as the 'haute couture' (from the French language, meaning high-class dressmaking; leading dress designers collectively, or their products). Subsequently, when the numbers of haute couture designers grew, a trade association was formed to determine the qualifications of a couture house and to deal with their common interests. Consequently, La Chambre Syndicale de la Couture Parisienne was found in 1868. Membership was, and still is, limited to couturiers who meet specified qualifications and who abide by a set of rules laid down by the Chambre to control the schedules of fashion shows, issues of originality, shipping dates and so on.

French origin is not a qualification for membership to the Chambre. As in the past, many of the most famous Paris couturiers have not been French. Members show their exclusive collections twice a year in January for the Spring/Summer and in July for the Autumn/Winter seasons.

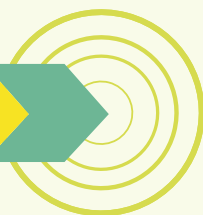



Today, the Paris haute couture is an industry unto itself, very important from the prestige point of view.

The other important couture industry outside Paris is in Italy. The Italian couture was organized after World War II along the same lines as Paris but on a much smaller scale. The Italian counterpart of the Chambre Syndicale de la Couture Parisienne is the Camera Nazionale dell' Alta Moda Italiana. The Italian houses are not congregated in a single city but are located in three cities-Rome, Florence and Milan.

The experience of the Italian couture has been similar to that of the Paris houses. As couture prices are prohibitively high for the majority of potential customers, therefore, a substantial share of the income for these houses comes from their ready-to-wear sections, franchised boutiques, and the licensing fees from perfumes, accessories and other goods to which the designer name adds prestige. The designer items are special and very expensive. The daily-use items, on the other hand, are more accessible; they satisfy the dreams of the general customer who wish to possess a quality brand name product at an affordable price.

Names like Donna Karan and Calvin Klein from the US, Alexander McQueen and Vivien Westwood from the UK, Giorgio Armani and Missoni from Italy, and Issey Miyake and Kenzo from Japan are among some of the designers who have attained international prominence.

3.1.3 High Fashion Ready-to-Wear

Ready to Wear is derived from French word 'Prêt a Porter', which means 'off-the-rack' or 'off-the-peg'.

Stitched garments in varied sizes, ready to be purchased of the rack were originally a minor sideline of a few couture houses. However, this side of the industry has steadily grown into a full- fledged industry, not only in France but globally for all designers across the world. Contributing to its development were ready-to-wear producing companies and designers, like Sonia Rykiel, who began to attract the attention of foreign buyers by developing styles and a look of their own that was different and fashionable. The garments were substantially lower in price than the couture garments, hence serving a broader clientele. Many other designers launched their ready-to-wear lines thus joining the band wagon. A few of these are Gucci, Calvin Klein, Paul Smith and Kenzo.



Fig 3: Gucci: One of the most famous ready to wear fashion brand in the global industry

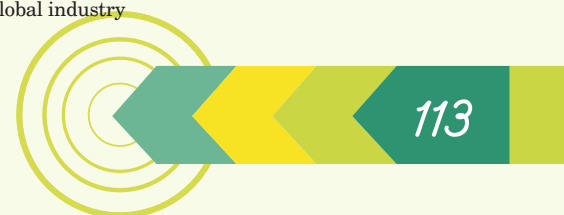



Each ready to wear designer or a brand has a distinctive style and may create two or several collections every year. The designer can sell ready -to- wear line under his prêt line designer name or through a separate brand name. Further, the designers may have their own manufacturing facility or else have arrangements with high quality fabricators and manufacturers placed in different parts of the world .

Many of these ready-to-wear designers have been designated as 'createurs' by the Chambre Syndicale and have been admitted as members.

As in France, the ready-to-wear industry developed like in other fashion capitals, such as New York, London, Milan and Tokyo. Promotional activities, such as trade shows and trade fairs, are organized at least twice a year for Spring/Summer in August- September and Autumn/Winter in February-March. These fashion related trade shows and fairs are conducted in several important cities across the world to create a buzz, to set trends and to attract buyers.

3.1.3.1 London

British fashion is famous for its eccentricity reputation and plethora of quirky ideas, its creativity and 'street fashion'. British fashion has also long been known for its traditional style, especially its tweeds and men's custom tailoring. The presence of influencing fashion icons in Britain in past like 60's super model Twiggy, Princess Diana, Alexander Mc Queen etc. made indelible impressions not only on the lifestyles of British people, but also on fashion followers viewing them across the world.



Fig 4: An iconic Hop-in-Hop- off bus on London streets

The British ready-to-wear industry flourished during the 1960s. The avant garde, colourful and uninhibited clothes for young men and women of that decade that continued into the 1970s became synonymous with Carnaby Street. The trendy styles created by young fashion designers filled boutiques throughout London. And boutiques for young people, who for the first time had money to spend, literally mushroomed in the British capital and other major cities of the UK. The fresh and free-spirited attitude of the time was reflected in the short mini-skirted dresses, flower and paisley designs on cotton muslins, silk satins, chiffons, velvets and wool fabrics. *British fashion for the first time had the younger generation setting the trends instead of following the fashion path of the older generation.*

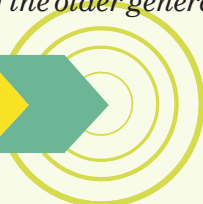



It was Mary Quant, a young English designer, who particularly understood the wave that was changing the perceptions and social attitudes in her country and beyond. She made a significant contribution to the new look of fashion by introducing mini skirts to every fashion follower's wardrobe. It was from here onwards that, the English fashion industry succeeded in capturing the imagination of the young, trendy customers as well as their fashion-conscious elders.

3.1.3.2 MILAN

Italian style is undoubtedly the most mature expression of aesthetic appeal with a practical orientation, as can be seen in its interior design, lifestyle products and fashion. Italy's strength and competitive advantages derive from its high quality fabric, its fine workmanship and the innovative elegant styling of its knitwear, sportswear and accessories, particularly leather shoes and bags.

The Italian ready-to-wear industry developed along with its couture industry, but the former started exporting earlier than its haute couture. Italian goods command a very high value in foreign markets because of their product image, built upon the excellent standard of their design aesthetics and the high quality of Italian textiles and fabrics. Even today, the fashion industry thrives on foreign sales efforts supported by the Italian government.

Milan has become the major staging ground for Italian ready-to-wear shows. In fact, many ready-to-wear companies in Florence have relocated to the north, and they show both in Milan as well as in their home-base, Florence.

3.1.3.3 NEW YORK

American fashion is straightforward, sensible and businesslike, aimed at the average consumer. The American approach has always been to solve the problems of the customer, and in doing so the U.S. has earned the reputation of being the first country to design active and casual sportswear. Claire McCardell, Donna Karan and Anne Klein have contributed path-breaking concepts to the ready-to-wear fashion industry.



Fig 5: Statue of Liberty, New York, statue is not the hub the city is one of the most influential fashion hub

Among the apparel elements that have been especially developed by this country's fashion industry and those which are today synonymous with casual wear world-wide



are jeans, swimsuits, wrap skirts, jogging pants, sweatshirts, body suits and track suits.

The New York fashion industry responds well to the real needs of its customers who look for clothes that make them look good and yet are comfortable and appropriate for their dynamic lifestyles.

New York City is the wholesale fashion centre of the U.S. Almost all the world's leading fashion designers have their offices in New York. It is indeed the business capital of fashion. Twice a year members of the international fashion world come together in midtown Manhattan to conduct business worth billions of dollars. They shop around for new ideas, new designs and, above all, are alert to a unique commodity-the reality factor. The American designers are not just fashion designers but also excellent marketers who leave little to chance in following and trying to meet their customer's desires and lifestyle choices.

The textile industry of America, for instance, proactively follows prevailing lifestyle trends, and has thus created several innovative fibers and fabrics that have revolutionized the fashion scene. Nylon, polyester and lycra have become household terms across the world.

3.1.3.4 Paris

The French had been looked to with great admiration for their dress sense well before Haute Couture began in the 18th century. In the 18th century, couturier Rose Bertin was named the Minister for Fashion and the position was still retained in the Napoleonic era.

Initially, it was the rich and powerful, telling the designers what they wanted to wear in clothes, but in the 19th century, this changed. It was surprisingly, an Englishman working in Paris who became the father of modern fashion design when Charles Worth put his name on his clothing labels, thus, inventing the first design label. He went a step further, creating designs based on his own ideas and displaying them on live models so that clients could approve or disapprove. The novelty was a success and designers then began to dictate what was fashionable.

From then on, it was understood that any designer who wanted to be a success had to be in Paris and become part of a couture house or form their own. Paris thus always has been the home of fashion shows. All the fashion magazines were either based in or



Fig 6: Eiffel Tower, Paris; couture's paradise

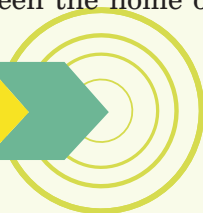



looked to Paris for their information. For women throughout the Western world, Paris was the epitome of fashion clothing and lifestyle.

Paris has been home to the worlds most influential designers like Chanel, Dior, Yves Saint Laurent who changed the perception of how not only women looked but the way world viewed them. A designer, in order to cement his hold on his customer base, progressively adapts to the shifts in his customer profile and hence the obvious extension to couture was introduction of designer ready to wear labels, licensing perfumes, accessories and other goods. The same trend has been followed globally for couture brands establishing in various parts of the world.

3.1.3.5 Tokyo

The Japanese production industry has transformed remarkably in the recent years. In the process, Japan has made popular a unique style which has developed with the Japanese fashion makers, blending the knowledge of world fashion with traditional Japanese aesthetics and concepts of beauty.

Today, the fashion industry in Japan is at the top of the list of growth industries, and it is doing extremely well in the area of fashion. Many designer names in Japan have become famous for their ingenious concepts.



Fig 7: Tokyo; a fashion city demonstrating amalgamation of technology with its cultural heritage in its intrinsic product development

To mention just a few, Issey Miyake, Rei Kawakubo of Comme des Garcons and Yoji Yamamoto are renowned for their unique creations.

In order to capture the world market, Japan lays equal emphasis on its textile and apparel industry. The Japanese designers participate in international trade shows and have offices in European cities and in New York.

3.1.3.6 Emergence of India as a Fashion Centre

India has seen a huge economic growth over the past decade. The influencing factors like its colossal IT industry, back office operations for international market and opening of economy etc, has led to increase in the annual income of the average house hold. This has led to a sudden explosion in the purchasing power of its population.



There has been a notable need for comfortable and fashionable office wear, casual wear, club wear, and formal ethnic wear. Influenced by globalization and immediate access to information there is a desire to create an impression. The Indian consumer today lives in a global village where she interacts on a daily basis with a heterogeneous mix of cultures, with in which she needs to establish her own unique identity.

India, with a plethora of its heritage weaves, crafts and skilled labour, has been successful in establishing design houses that serve national and international consumers. Designers like Ritu Kumar, Manish Arora, Sabyasachi Mukharjee, Raghvendra Rathore and many more are iconic and have global presence. Design and fashion events such as the Wills Lifestyle and Lakme India fashion weeks give a platform to young designers to showcase their talent in

national and international trade markets. The fashion market, though nascent in India, has grown leaps and bounds over the years. The country is further opening up to international retail brands and hence looking forward to more design challenges, thrusting growth towards better design opportunities and markets.



Fig 8: World renowned designer Ritu Kumar awarding emerging designer Fazal Ahmed for outstanding creation in his graduating collection, year 2010

3.1.4 Ready-to-Wear and Mass-Produced garments: Off-Shore Manufacturing

Ready-to-wear and mass produced garments are produced in large quantities in low wage countries at very low costs. As labour and infrastructure is very expensive in Europe, Japan and the US, the apparel industry out sources its manufacturing from countries where wages are low yet the labour force is highly skilled.

In the Asian belt, China, India, Sri Lanka, Pakistan, Bangladesh, Thailand, Mauritius and Malaysia are centres of manufacturing. In South America, Mexico is the prime centre. In Europe, Poland, Portugal and Turkey have become important clothing manufacturing countries. These countries have been mass producing low cost ready-to-wear garments and accessories for the Western markets. The produced apparel is sold at





affordable prices in departmental stores across Europe, North America, Australia and New Zealand, as well as in the countries where it is produced.

The mass-manufactured garments are usually simplified knock offs of the up-market labels and brands. Every effort is made by the producers to cut down on the cost of manufacture. Large quantities are produced in order to bring down the per unit cost, making the apparel affordable for the masses. In the recent past, China has emerged as a production giant, selling any merchandise they produce at unbeatably competitive prices.



Glossary

- ❁ **Fashion:** An ever changing, vital and influential force that impacts our everyday lives.
- ❁ **Fashion Capital:** A city which has the potential to be a major centre for fashion industry in which activities of production; retailing of fashion goods; hosting of fashion events and fashion related trade fairs generating significant economic output can be held.
- ❁ **Haute Couture:** French word for high- class dressmaking.
- ❁ **Boutique:** A small shopping outlet, especially one that specializes in elite and fashionable items such as clothing and jewelry
- ❁ **Street fashion:** Any offbeat fashion inspired by contemporary culture of urban street people.
- ❁ **Designer/High-end Ready-to-Wear labels:** Products designed by designers, known for quality and innovative styling, made in standardized sizes and usually manufactured with finesse in factories.
- ❁ **Ready-to-Wear, Mass-Produced garments:** Manufactured off-shore, coming out of low wage countries at lower costs.
- ❁ **Off-shore manufacturing:** Production of goods in countries beyond the geographic boundary of the retailing company.
- ❁ **Avant garde:** Styles or fashion that are designed or are prevalent ahead of their time.

Exercises for Chapter – 1

Fill in the blanks:

1. is a French word for high- class dressmaking.
2. is a French word for ready-to-wear garments.
3.,, and are four big fashion capitals of the world.
4. is the oldest fashion capital.
5. is the business capital of fashion.
6. was named the Minister of Fashion in 18th Century France.

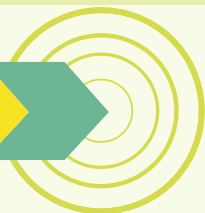



7. Production of goods in countries beyond the geographic boundary of the retailing company is called
8. is a small shopping outlet, that specializes in elite and fashionable items which are sold at higher prices.
9. and are two reasons which offer Indian designers an extra mileage to create their exclusive collections.
10. Introduction of mini skirts to women's wardrobe can be credited to designer.
11. is the country which can be credited to introduce casual and sportswear garments in the fashion industry.
12. Fashion products fall into basic categories of, and
- 11are the styles or fashion that are designed or are prevalent ahead of their time

Review Questions

1. Name the 'Big Four' fashion capitals of the world.
2. Write short notes on any two fashion capitals of the world and their contribution to the fashion industry.
3. How has France sustained its image as the centre of fashion?
4. Name a few emerging fashion centres around the globe.
5. What are the reasons which have contributed to the emergence of India as a fashion centre?
6. State the difference between Haute Couture and Hi-Fashion Ready-to- Wear apparel.
7. Who are Haute Couture producers?
8. What the need for the French Trade Association to be formed?
9. Name three cities where Italian fashion houses are located.
10. Why do Italian garments command a high price?
11. What is British fashion famous for? Name the British fashion icons who were influential in 1960s.
12. What are the reasons for outsourcing manufacturing of garments?



FASHION STUDIES

Activity

Fashion reflects a society's prevailing customs at a particular time. The exercise is designed to enable the students to explore the existence of different fashions evolving through the decades of 50's, 60's, 70's and 80's. Thus, helping them understand reflections of the society's customs i.e. it's political, economic and cultural state during the mentioned decades.

Collect pictures from the internet, magazines or newspapers for decades of 50's, 60's, 70's and 80's in the categories of:

- a. Womens fashion
- b. Interior fashion

Place them in your scrap book and write about each in 10 bulleted points.



Menswear

3.2.1 Introduction to Menswear

In the Western world, until the mid - twentieth century, the average man's wardrobe consisted of few options. He would have one or more of dark suits with matching vests, white shirts and a selection of dull coloured ties. After World War II, this was found to be on the path of change.

From 1950s onwards, the younger generation of men wanted to indulge themselves and live life to its fullest, preferring less working hours and more family-oriented leisure activities. This inevitably, led to the need for sport's and leisure wear. By 1960s, the popularity of music groups such as the Beatles and their influence on the young generation sparked the demand for greater variety, faster change and new opportunities for the expression of individuality. Menswear continued to experience dramatic changes throughout the 1970s and the 80s.

'Women are fashionable but men are not' is a popular (but erroneous) notion which stems from the presumption that men dress only for comfort and functionality, not for style or fashion, as in the presumed case for women.

Unfortunately, and quite inaccurately, men who are interested in fashion are considered by many to be 'peculiar' and probably decadent. A man's profession highly influences his wardrobe and style. Certain professional fields such as advertising, theatre, architecture and fashion are perceived as being more creative than banking, law, medicine and corporate business. These latter professions are, on the other hand, more highly placed and valued in society than the 'creative' fields. These categorized professions have also contributed to the labeling of professionals in the creative vocations as more idiosyncratic, thus less 'serious' and 'mainstream' than their supposedly scientific, intellectual and pragmatic fellows.

In the emerging world of capitalism and political democracy, menswear has been greatly influenced by the corporate culture of multinational companies which greatly emphasize on the look and image of their work force. A corporate look is marked by wearing suits, shirts and trousers, accessorized with ties in the current fashion trend.

In the late 1980s, the concept of Friday dressing was introduced by the corporate industry in the US. The dress code was relaxed on the last working day of the week (i.e. Friday) to bring in the feeling of weekend just around the corner. This relaxed the uptight dress code in offices, which led to an attitudinal shift in the overall world of menswear fashion.

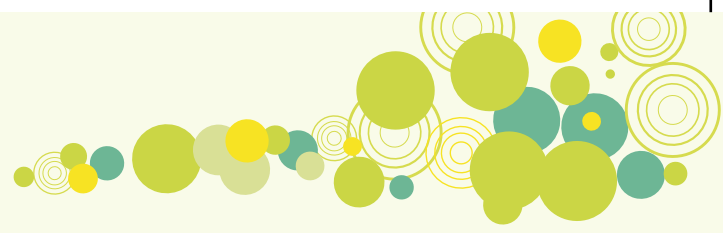

In the past years, the functional, tough - looking military uniforms and industrial work wear have inspired many top brands and designers. The classic example was the emergence of denim jeans (originally worn by the gold miners of California in 1850's, made from strong and durable fabric) in the mainstream menswear apparel. The introduction of jeans in mainline clothing broke the social and economic barriers prevalent at that time. Jeans have since then, remained timeless classic clothing for more than a century.

In due course of time menswear has become more individualistic, follows present trends and differentiates its markets based on lifestyle, personality and attitude. For instance, junior men's fashion is highly attitude-driven and is influenced by sports, music channels and fashion icons.

3.2.1.2 Categories in Menswear clothing

Menswear clothing can be divided into the following categories -

- ✦ **Casual wear** clothing can be worn during leisure activities or informal occasions. Examples of such clothes are T- shirts, Jeans, Cargo pants, shorts etc.
- ✦ **Sportswear** clothing is worn either while playing a sport or are simply inspired from any sports activity. These are informal interchangeable separates. These clothes may not necessarily be worn only while playing a sport but may be flaunted even while watching it. Basketball T- shirts, tennis skirts, jogging pants etc are examples of sportswear garments.
- ✦ **Active sportswear** clothing are meant to be worn while specifically participating in a sports activity like swimming, scuba diving, hiking, skiing etc. The examples of such garments are swimming costumes, hiking pants, ski jackets etc.
- ✦ **Formal wear** clothing is worn during formal occasions related to office or for a specific formal occasion. They can be divided into ethnic or western. Ethnic category may include sherwanis, churidars, kurtas, dhotis and pyjamas. Western category may include trousers, shirts, jackets and suits.

However, with the effect of globalization the distinction between ethnic and western is being blurred by creation of fusion garments like Jodhpuri pants and Nehru jackets.

- ✦ **Outer wear** is clothing which is designed to be worn outside, over other garments. Cloaks, jackets, overcoats, raincoats, robes etc. are some of the examples of outerwear garments.

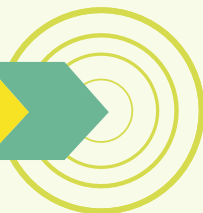



3.2.2 Colour in Menswear

Colour is the prime attribute of a menswear garment. The most commonly worn colours used in menswear clothing are the cool range of blues, earthy browns, smoky greys, shades of greens and neutrals. Generally, the colours used in menswear are more conservative, emphasizing masculinity and objectivity. (On the other hand, the 'feminine' colours are commonly from the warm spectrum and are thus classified as 'subjective'.)

Colour is not separated from pattern. Even solid colours can be considered as patterned when combined with other solid or neutral colours, for example chambray fabric. The combinations of colours can create patterns like stripes, checks and plaids. Plaids and stripes, though not exclusively masculine, have much stronger male identification than floral, which are generally perceived as more feminine.

3.2.3 Fabrics for Menswear

Fabrics for menswear are usually firm, masculine and formal as compared to womenswear. Traditionally, fabric manufacturers producing fabric for menswear did not venture into womenswear because the needs of the two markets were extremely diverse. Although, occasionally it may seem that they share or take ideas from each other.

The fabrics for shirtings are lightweight. They are usually in cottons, linens and in blends of synthetic and natural fibers.

Suiting and trouser fabrics are heavier, usually blended for desired quality and comfort. With technology upgradation there is an availability of improved fabric quality. Fabrics have become lighter and supple, and several types of desirable finishes can be applied to them, such as wrinkle free, stain resistant, waterproof and anti-static finishes.

Casual wear garments are frequently made from fabrics like canvas, gabardine and denim. However, with the increase in the official working hours of today's generation; the distinction between official hour and personal hour of men has blurred. Hence, fabrics like linen and fine cottons are more in trend and usage. These fabrics provide comfort, flexibility and air absorption for use over long working hours.

3.2.4 Classic Shirt and its types

A shirt is a very important garment in the mens wardrobe. Shirts cover the upper half of the body, called the torso.

A shirt may be cut, in order to hug the body or fall straight from the arms. It may also be cut loose to provide room and comfort. There could be enumerable ways of styling a

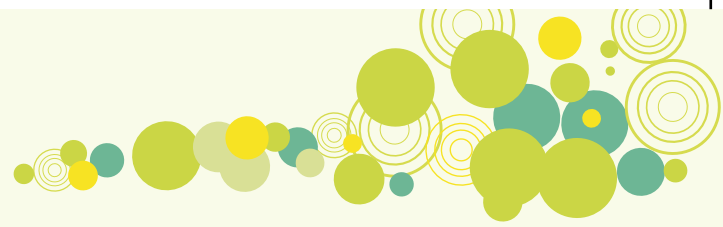

shirt. Shirts could be styled to emphasize the neck, shoulders, chest, biceps or the waist.

The collar and a short forms very important detail in the shirt, as it adds to the personality of the wearer. There are a variety of collar designs, such as the band collar, shirt collar, wing collar, buttoned-down collar, etc. The width of the collar can also be styled to create different looks.

Shoulder details on the shirt like the epaulets or a shoulder yoke can be used to give an impression of a broad shoulder.

Shirt sleeves can be short or long, tight or loose. A variety of cuff designs can also be added to the sleeves. There can be shirts without sleeves also. The shirt hem can be straight or curved. The front placket of the shirt can be narrow or broad, single or double stitched.

An Oxford buttoned - down shirt is suitable for a crisp formal look. The Oxford is usually made in solid colours, typically pastel or mid - tones, often in interesting stripes and small checks.

A dress shirt is usually of a light colour, and is designed specifically to be worn with ties and suits.

The Hawaiian shirt is loose and airy and half sleeved, made of large foliage prints in bright, cheerful colour fabrics in cotton.

A T-Shirt is a casual, non collared or collared shirt made up of knitted fabric.

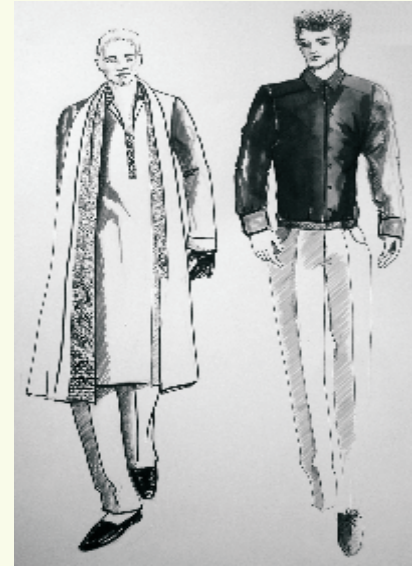

Fig 9: Menswear Kurta Pyjama (Left)
Casual Shirt and Trouser (Right)
Illustrations: Amritha Shree Kumar

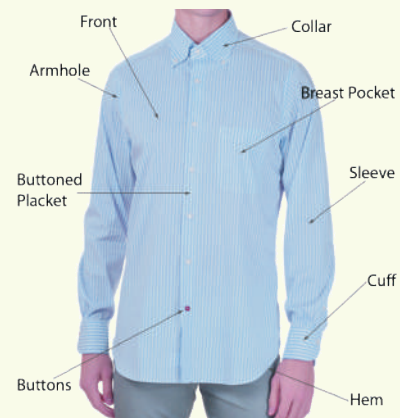
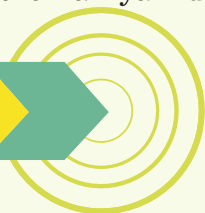

Fig 10: Parts of a shirt

3.2.5 Bottom wear - Pants

Pants are bifurcated garments for the lower half of the body. Pants may be cut to be straight legged, flared or pegged, with bottoms that may be narrow or wide, flared, or cuffed. Pants can be cut with a high waist or a low waist, with buttons or a zip fly. In general, straight leg trousers are designed to fit the body comfortably, but not tightly. Pants can be flat front or pleated to give different type of looks and fit to the wearer. In order to achieve a good fit and comfort the fabrics used in pants are infused with stretchable properties. This is achieved by using various elastomeric yarns along with the main yarn during weaving.





Commonly, for constructing casual pants, fabrics like chinos and khakis are preferred above denims.

For dressy pants or trousers, refined wools and blends are used. Both pleat and cuff details are optional, and pocket treatment is minimal, usually consisting of slits and welts.

Baggy trousers are loose around the hips but narrow down at the bottoms. They usually have deep pleats at the waist to provide the necessary volume.

Cargo pants are inspired by military uniforms.

They are characterized by camouflage - inspired prints and large utility pockets.



Fig 11: A contemporary menswear collection demonstrating variation in traditional Jodhpuri trouser, with a jacket to suit today's market trends

Jeans are the most popular types of pants for men. These are casual pants made up of Denim fabrics.



Fig 12: Menswear; Two Piece Suit

3.2.6 Shorts

Shorts are informal bottoms that reveal the calf and thigh.

Shorts can be Bermudas that reach until the knee caps in a stove pipe fashion. They generally have very little extraneous detail.

Khaki and safari shorts are rugged, particularly when they are detailed with buckled straps, zippers and pockets with military detailing etc.

3.2.7 Suits

A suit can be two to three piece garment worn with a shirt inside. A suit can be styled to give a formal, evening or a casual, sporty look.

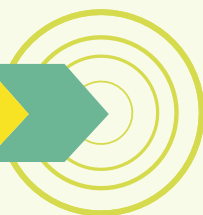



Fig 13: Menswear Three Piece Suit

When elegantly cut in dark smooth fabric, the suit is invariably formal. If double-breasted, it can look very powerful for a business attire. A dress shirt with accessories, such as an elegant tie or a bow tie and cuff links, further enhance the formal style.

When coordinated with a polo neck or a T-shirt, the suit takes on a sporty look. Made from lighter shades and cool, light-weight fabrics, the suit has a less formal character. Coordinated with a striped or a check shirt, a suit looks decidedly casual.

An additional waistcoat in two piece suit makes it a three piece suit.

Suits can be single breasted or double breasted depending on the overlapping of the front bodices of the coat.

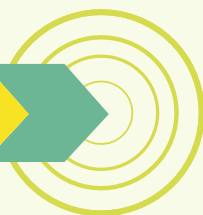

Fig 14: Indian designer creations, serve the aspirational needs of menswear for its niche segment

3.2.8 Indian menswear fashion market today:

With the extensive options in the professional careers of Indian men today, ranging from IT industry to the varied avenues in the creative fields, the demand for a stylish and a professional look in the menswear category has spurted vastly.

The brand awareness among the consumers for good quality and service standards has led the international and national brands to focus on the customers residing in the metros and the smaller cities in India. The increase in the disposable income and the willingness to spend more among the consumers has also broadened the menswear market. Some of the key players of the menswear market are Madura Garments, Provogue India Ltd., Indian Terrain, Raymond Apparel Ltd., Levis Strauss & Co. etc.





Glossary

- ❁ **Shirts:** A garment to cover the upper half of the body, called the torso.
- ❁ **T - Shirt:** A casual, non collared/collared shirt, made up of knitted fabric.
- ❁ **Pants:** A bifurcated garment for the lower half of the body.
- ❁ **Baggy trousers:** A garment loose around the hips but narrow down at the bottoms.
- ❁ **Suit:** A two piece garment wore with a shirt inside.
- ❁ **Colour Palette:** Determines the colours, tones and the texture of the fabric.
- ❁ **Casual Wear:** Informal or everyday clothing.
- ❁ **Epaulets:** Buttoned flaps in a shirt on either side of the shoulder.

Exercises for Chapter – 2

Fill in the blanks:

1. The menswear apparel category can be divided into.....,,, and
2. was a popular group of music band which had mass fan following in the decade of 60s bringing a dramatic change in the menswear dressing.
3. and are examples of garments fusing ethnic and western sensibility.
4. added to a two piece suit makes it a three piece suit.
5.,, and are three commonly used fabrics for menswear casual pants.
6., and are commonly used patterned fabrics for menswear shirting, created by the combination of colours.
7. Three collar variations for menswear shirts are, and
8. are buttoned flaps in a shirt on either side of the shoulder.
9. is a look marked by wearing suits, shirts and trousers, accessorized with ties.
10. The concept of was introduced by corporate industry in the US to relax the uptight dress code in offices.
11. A is a casual, non collared or collared shirt made up of knitted fabric.

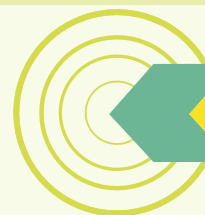



Review Questions:

1. After 20th century, menswear experienced dramatic changes in their wardrobe. Give reasons for these change.
2. Write short notes on the categories of menswear clothing.
3. Write a short note on menswear ethnic clothing.
4. Write a short note on factors that have influenced menswear clothing.
5. Name the fabrics preferred for mens clothing.
6. Name the types of shirts.
7. Differentiate between a shirt and a T-shirt.
8. What fabric can be used to achieve good fit and comfort for pants?
9. Classify the menswear market.

Activity

In order to cater to the specific needs of menswear apparel market the clothing is divided into casual wear, sportswear, active sportswear, formal wear and outer wear categories.

Since clothing is specific to an occasion, the understanding of these categorizations is important. The activity is designed to enhance the student's ability to analyze the clothing and objectively place them under the defined heads.

Collect pictures from internet, magazines or newspapers of:

- a) Casual wear
- b) Sports wear
- c) Active sportswear
- d) Formal wear
- e) Outer wear

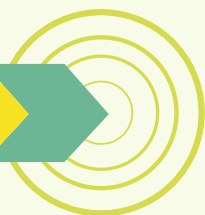



Womenswear

3.3.1 Introduction to Womenswear

"Fashion is not something that exists in dresses only. Fashion is in the sky, in the street, fashion has to do with ideas, the way we live, what is happening." by Coco Chanel.

Womenswear has always enjoyed the centre stage in fashion.

Clothing in past were custom made i.e. stitched for an individual using her body measurements by a tailor or a dressmaker. During earlier centuries the majority of women, however, wore clothes made at home by the women of the house.

The introduction of the domestic sewing machine revolutionized the home manufacturing of clothes by substantially reducing the long hours of hand sewing. To help in the home sewing operation, several womenswear magazines started giving instructions on how to sew the garments. Later, paper patterns for fashionable styles in graded sizes became available. Thus, home dressmaking continued to prevail for a long time.

At the turn of the 21st century, however, a new breed of very active women began to emerge. Women were no longer spending their lives at home. They were now studying, teaching, indulging in sports activities, politics and working in offices. Their growing interests and activities took them out of their homes and made ready-to-wear clothing a convenient answer to suit their new lifestyle.

This radical social change among women naturally led to a gradual shift towards simple silhouettes, away from the elaborate clothing that had prevailed in the past. This new clothing which was easier to produce and cheaper to afford got wildly accepted among various social classes. This social change coincided with the development of manufacturing facilities for large-scale production of ready-to-wear garments.

With changing times, the role of the women have become multi dimensional; from handling office to home; to kids and simultaneously balancing their social and personal responsibilities. Working for home or for office, with a hectic schedule has led to the requirement of an easy to wear, maintain and comfortable dressing, which has become a necessity for today's lifestyle.

There is a huge market with various segments of women with explicit needs. Many brands like Levis Curves, Allen Solly, Marks and Spencer address these requirements with their apparel lines based on specific market requirements of sizes, ethnicity and occasions. Introduction of garments for plus size women and maternity wear also acquired considerable share.

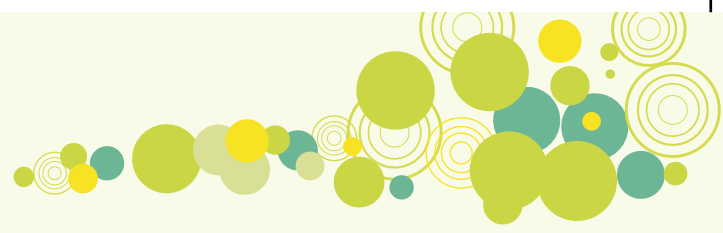

The experience of mass manufacturing uniforms for men and women during the two world wars facilitated the preparation of size charts for the western consumer.

3.3.1.1 Influence of Trends on womenswear

Women's ready-to-wear garments follow specific trend prediction for the season to enable the designer, fabric manufacturer, garment manufacturer and retailer to plan the design and production of garments at least 18 months in advance of the actual season of sale.

The prevalent trends are perceived and analyzed by each company to create a mood board suitable for their clients for a particular season.

Couture and *Prêt a Porter* shows held in Paris, London, Milan and New York are the main source of fashion trends for womenswear.

The shows are held twice a year. At the time of the shows all the partners in the fashion value chain; i.e the fabric manufacturers, garment manufacturers, buyers, retailers and fashion editors, flock to these cities to review the new styles.

As soon as the shows are over the fashion editors select styles they feel are prophetic, and splash trend features and stories with glossy pictures of the styles in fashion magazines and newspapers. Consumers become aware of the latest trends through these magazines and media broadcasting. The retailers and manufacturers wait for professional analysis of the trends by trend analysts and agencies that also study the changing lifestyles of the consumers who segregate trends for various market nationally and internationally. The preferences and aesthetics of the American consumer, for example, are different from those of the Italian or British. The trend forecast information indicates the new colour palette, the new fabric trends, surface treatments, silhouettes and design details.

3.3.1.2 Indian womenswear

Indian womenswear market continues to be largely driven by Indian aesthetics infused with the regional sensibilities inspired by the Moghul and British influences over a period of time. Traditionally Indian women wore draped styles; it is only since a little more than two hundred years ago that the sari is being worn in the present avatar that is 5-1/2 yards to 8 yards with a stitched choli or a blouse.

It was during the Moghul rule that Indian women were introduced to stitched garments such as the salwar kameez, kalidar kurta, pyjama, sharara and gharara. *Karigars* are weavers, tailors and embroiderers who were specially brought in from the Moghul countries to make garments for the Moghul royalty. They settled down in India for several generations and never went back, which also explains the reason for the finest tailors and embroiderers belonging to the Muslim community today. The





Moghul style is very feminine, elegant and dignified. The beautiful embroideries done by muslim karigars such as chikankari, ari work etc., further enhance the beauty and richness of the style and in the process have also influenced the Indian saris.

Another influence impacting the Indian womenswear was the British influence of tailored jackets, blouses, pants, dresses and gowns. The Indian tailors were trained by the British rulers to stitch western garments for their women who followed their husbands to live in India. The British influence was somewhat limited in the Indian womenswear category. However, the menswear clothing for work, followed by casual wear was extensively revolutionized.

Today, we see a comfortable and seamless coexistence of Indian, Moghul and western style in Indian womenswear.



Fig 15: Indian Womenswear: A contemporized variation in traditional Kalidar Kurta and Churidar

3.3.2 Elements of Design in Womenswear

The three primary elements that make a garment are its colour, fabric and shape.

3.3.2.1 Colour

Colour prediction in womenswear is very important. Every season the palette has four groups: pastel, neutral, bright, and deep colours. It starts with the overall mood, and it is this that determines the colours, tones, the texture, the accents in the theme, whether the look will be vintage, washed-out for one season or fresh and soft colours for the next is determined by the chosen theme.



Fig 16: Different coloured prints and stripes of womenswear

3.3.2.2 Fabric

Fabric is the fundamental element of a garment and is responsible for 50%-80% of the cost of the garment. Texture, handle and surface qualities of a fabric play an important role in achieving the total effect of the style. Apart from the natural fibers



like cotton, linen, silk and wool; there is a large variety of man-made fibres to choose from.

Technological developments have led to the creation of soft, stretchable, user-friendly, easy-to-care and excellent quality in fabrics. Blended fabrics give the desired qualities with a natural feel and comfort. Each season fabric manufacturers present their new collections of fabric in tune with the forecasted trends.

Printed and woven designs, surface in womenswear embellishments and trim details are important elements for the overall style.

Prints and woven designs can be in a variety of patterns like small, delicate florals (as in Laura Ashley prints); large florals in bold colours, soft water colours, geometric designs, stripes (both broad and thin), checks - gingham, madras and small plaids.

Embellishments may include appliqués, hand and machine embroideries and other decorative techniques applied on fabrics and garments. The created surfaces may be in tune with not just the fashion trends for the season, but also showcasing the cultural plethora of the Indian embroideries that are the part of our heritage.

Trims are types of closures which include buttons, zips, etc., as well as piping and interlinings used in the garment.

3.3.2.3 Shape / Silhouettes

A silhouette is the shape or the outline of the clothing when worn. The basic shapes or silhouettes of each season can change suddenly or evolve slowly. Different combinations of shapes made by separate garments worn together lends style to the overall shape or silhouette of the outfit.

3.3.3 Garment Collections

Garment collections are designed as a group of coordinated pieces that can be made from fabrics, colour palette and details following the same story. A garment collection can start with 10-15 garment pieces.



Fig 17: Different shapes of womenswear garments





Fig 18: Design innovation with amalgamation of traditional art and craft with contemporary silhouette and styling

Separate collections are designed for evening wear, sport wear, casual wear, street wear, formal wear, night wear and maternity wear categories. Every product category is designed to cater to individual customer category, such as womens, missy, petite and junior.

Following are the products common to most of the regular categories in womenswear.

3.3.3.1 Dresses - Dresses are long continuous garments worn over the body. The variations in dresses can be achieved through manipulating its length, waist line, flare and seams. The variations created with these elements will determine the ultimate fit of the dress.

Empire line dresses, Princess dresses, shift dresses are some of the examples of dress variations.

3.3.3.2 Blouses - Blouses cover the upper half of the body of a female. The different styles in blouses can be achieved through variations in bodice, collar, sleeves and placket.



Fig 19: Basic shift dress with spaghetti straps



Fig 20: Dress with the variation in waistline and seams

- A: Long length empire dress
- B: Short length shift dress with waist line variation
- C: Mid length paneled dress
- D: Basic knee length Dress with a smoked waist top
- E: Short length Corset dress
- F: Box pleated short dress worn with a jacket

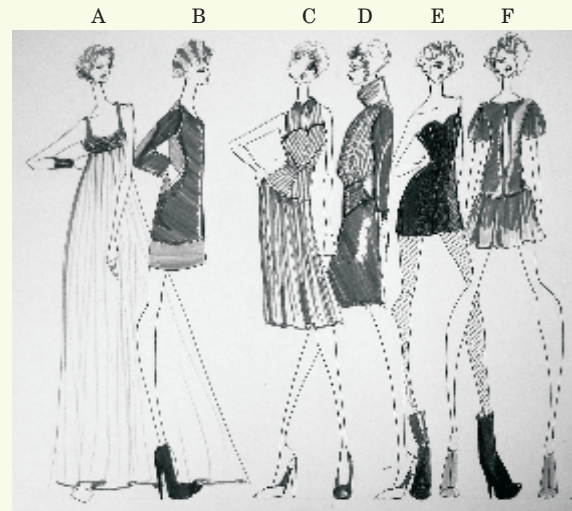

Fig 21: Dress variations
Illustrations: Amrita Shree Kumar

3.3.3.3 Skirts - Skirts are garments that cover the lower half of the body. They can be straight, flared, gathered, pleated, tiered or paneled. Skirts can vary in length from mid thigh to ankle.





- A: Short flared skirt teamed up with princesses seamed blouse
- B: Mini skirt teamed with yoked and gathered top
- C: Pleated skirt with basic V neck blouse
- D: Tiered skirt with raglan top



Fig 22: Skirt Variations
Illustrations: Amrita Shree Kumar

3.3.3.4 **Pants** - Pants are bifurcated garments for lower half of the body. Some of the styles of pants are straight, bell bottom, Capri, harem and jodhpurs



Fig 23: Capri length pants with jacket style shirt



Fig 24: Outerwear jackets with full length trousers and basic tops



3.3.3.5 Kurta and Salwar - kurta and salwar are paired ensembles from the continent of Asia. Kurta covers the upper half of the body and salwar, the bifurcated garment covers the lower half. Some of the variations in kurta styling are kalidar, kurta with yoke, A-line and straight kurta. Similarly churidar and Patiala salwars are variations of plain salwar.



Fig 25: Indian Kurta and Churidar

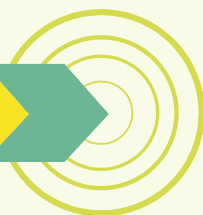

Fig 26: Contemporized Indian Ghaghra and Choli

3.3.3.6 Sari blouse - Sari blouses are stitched tops worn with draped saris. Plain and choli cut blouses are amongst the few variations of sari blouses.



Fig 27: Variations in Choli Blouses





4. and are the events held in fashion capitals like Paris, London, Milan and New York for showcasing the fashion trends for womenswear.
5. An is a complete set of garments co-coordinated to be worn from top to bottom simultaneously.
6. Garment collections designed as a group of coordinated pieces have similar and
7. The trend forecast information indicates the,,,and details.
8. Womens ready to wear garments follow specific, for the reason.

Review Questions:

1. State reasons which led to the requirement for easy-to-wear clothing for women.
2. Write short note on the various categories in womenswear clothing.
3. What are the three primary elements of design in a womenswear garments?
4. Write a short note on the influence of fashion forecasting and trends on womenswear.
5. Explain the role of fashion editors after fashion shows.
6. Name some variations of womens kurtas.

Activity

In order to cater to meet the aesthetic needs and body measurements of a consumer, variations are created in the womenswear garment. Due to these variations the garment has the potential to achieve variety of looks.

The given activity helps the student to understand the variations in a garment.

Collect pictures from the internet, magazines or newspapers of womenswear dresses with variations in their:

- a. lengths
- b. waistlines
- c. seams

Place them in your scrap book and discuss the same in class.

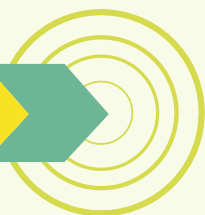



Childrenswear

3.4.1 Introduction to Childrenswear

Childrenswear, up until recently, did not fall under the purview of fashion. Children had to wear the miniature versions of adult clothing and imitate their elder's mannerism as well. However, today the global market for childrenswear is determined by the purchasing power of their parents and budding requirements of this ever progressive growing kids segment. Having recognized the increasing potential of this market segment, manufacturers and retailers are offering extensive varieties in their seasonal ranges.

With economic, technological and social advancements, the present day children have gained enormous exposure and knowledge. Simultaneously, with the growth in the financial status of the household for a large scale of working population has led to higher disposable incomes.

*"Fashion is a social occurrence which mirrors the same continuing change, those strides through any given time"*¹

Societal and economic changes, such as nuclear families with only one or two children and increased disposable income of both working parents, have had significant impact on the rearing of children. The faster pace of life, where working parents are forever running against time, has certainly had a direct effect on children's lifestyles.

Children are being increasingly pampered by parents with toys, clothes, access to computers, films, a plethora of TV channels to watch, play stations, sports, gimmicky stationery and accessories, etc.

Specialty stores are also catering to the needs of these little customers who have a strong opinion of the games they want to play, food they want to eat and clothes they want to wear. Some of the major influences on children's wear can be attributed to cartoon characters, films, bestseller novels for children, the latest technology, toys, TV channels, individual sports, and so on. Media, social networking sites like facebook and twitter, play stations, online shopping and peer groups influences have made children aware about the fashion trends and styles.

Manufacturers are forging tie-ups with TV channels, promoters of cartoon characters and other popular characters to create a host of special lines of clothing and accessories. Innovative ideas are being employed to launch products for children in the market. This multidirectional influence has led to more and more products come into the market , every year that specifically target children.

¹ Jarnow,J., Guerreiro. M and Judelle. B.1987. Inside the fashion business, Macmillan Publishing Comapny, New York, 1987, p.31

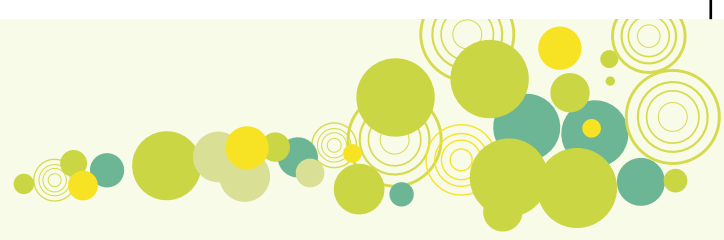

The popularity of sportswear has led to the development of many new fabrics which are breathable, highly absorbent and stretchable. It has also changed the technology of manufacturing and finishing. The influence of games such as football, basketball, baseball, cricket and hockey can be seen in the styling of track suits, sweat shirts, cycling and boxer shorts.

Childrenswear apparel category is different from menswear and womenswear because of the simple reason that children continue to grow. The changing body shape of the child as he/she grows and the basic requirements at different stages of this growth must be well understood before designing or creating a suitable garment for the child.

3.4.2 Newborns Clothing

Newborns are children aged from birth to few months. Newborns spend most of the time sleeping or lying on their backs, therefore the garments are designed while keeping in mind their comfort, safety and styling factors. In newborn garments no buttons are attached at the back, they are inbuilt into the garment with minimum third dimension in order to avoid abrasion and hence discomfort to the child. Hence, buttons like snap buttons and Vectro strips are preferred in garments for newborns.

Fabrics like flannels, knits in soft cottons and light in weight are used in newborn's clothing.

3.4.3 Infants Clothing

Infants are children from the age category of 3 months to 1 year. An infant's weight, head size and age are the major criteria's to be considered while selecting a garment. The head size of a small child is one fifth of his height, while for an adult it is one eighth of the body height.

Fabrics like flannel, jersey knits, polar fleece in cottons and other natural fibers are selected for infants. These are soft in handfeel and provide comfort to the tiny wearer who has supple and sensitive skin. Subtle, pastel colours with polka dots, nursery prints, checks and cartoon characters are preferred for prints. Solid colour fabrics are also in huge demand for garments. Trims used in infant's garments are less complicated and easy to handle like Velcro, snap buttons, soft laces etc. Globalization has created a huge market for branded clothing for this age group in India, over the past few years.



Fig 28: Frock (left), Shorts and T-Shirt (Right) for young girls

Illustrations: Amrita Shree Kumar

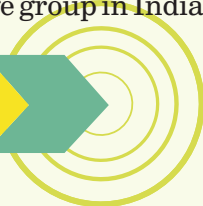



3.4.4 Toddlers Clothing

Toddlers are children belonging to the age group of 1 year to 4 years. In this age group the child develops basic motor skills and becomes physically more active. On account of their energetic behaviour and rapidly growing body, the fabrics preferred for their garments are from the easy to care and maintain category. Fabrics like Cambrics, poplins, codruoys, light weight denims, jersey knits, polar fleece are a few to name. Fabrics with bright colour palettes are usually selected for this age group. Printed and woven fabrics of gingham checks, stripes, polka dots and popular themes like cartoon characters become highlights for toddler's clothing.

However, in early childhood there is very little difference between the sexes in terms of body size and shape. Though with growing awareness among parents about fashion and trends, the colours of girl's garments are preferred to be pink and those for boys to be blue.



Fig 29: T Shirt and Pants (left), Shorts and T- Shirt (Right) for young boys
Illustrations; Amrita Shree Kumar

3.4.5 Preteens and Teens Clothing

Preteen is the age group of children from 5 years to 12 years and teens is the age group from 13 years to 18 years, but adolescence stage is also counted from the age of 15 years to 18 years, which becomes a part of teen age group.

This age group is characterized with the inset of puberty in boys and girls at various age growths. The average onset of puberty is at 10 or 11 for girls and age 11 or 12 for boys. Some of the most significant aspects of pubertal development involve distinctive physiological changes in individual's height, weight, and body composition. These changes in the body shapes of teens, requires different silhouettes and variations in garments to fit in the contours.

The manufacturers and retailers are capturing a huge market of licensed product for apparel, specially undergarments and nightwear of preteens and teens. Character licensed clothing is a very important aspect of business for this segment, since it is closely associated to adventure, sports and fashion. Since, the turnover of garments is very fast in this segment it is hence very lucrative for business.



Fig 30: Preteen dressing (From left to right)
Illustrations: Amrita Shree Kumar

- A: Shorts with basic T shirt
- B: Cargo trouser with basic shirt
- C: Flared Trouser with T Shirt and a casual jacket
- D: Flared dress with short waistcoat

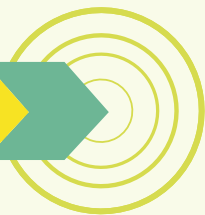



Glossary

- + **Newborns:** Children aged from birth to few months.
- + **Infants:** Children from the age category of 3 months to 1 year.
- + **Toddlers:** Children belonging to an age group of 1 year to 4 years.
- + **Preteen:** Children of the age from 5 years to 12 years
- + **Teen:** Age group of children from 13 years to 18 years

Exercises for Chapter – 4

Fill in the blanks:

1. Some of the major influences for childrens wear can be attributed to.....,, and
2. Childrens wear is different from menswear and womenswear for the simple reason that children continue to
3. Newborns are children aged from to
4. The reasons for using fabrics like flannel, knits etc for newborn's clothing are because they are and
5. Infants are children from the age of to
6. The head size of a small child is of his height, while an adult has of his height.
7. Toddlers are children belonging to an age group of to
8. In age group the child develops basic motor skills and becomes physically more active.
9. Change in the body shape occurs in age group.
10. The changes in the body shapes of teens, requires different and variations in garments to fit in the

Review Questions:

1. Write short notes about the factors influencing the expansion of childrenswear market.
2. State the differences between the newborn and an infant clothing.
3. Explain the elements of design for Preteens and Teens clothing.
4. Give 3 reasons for the growth of the childrenswear industry.



5. What creates awareness of latest fashion trends among children?
6. What are criteria for designing infants clothing?
7. Name 2 preferred trims for infants.
8. Why are easy-to-maintain fabrics preferred for pre-teens and teens?

Activity

In order to cater to the specific needs of childrenswear market, the clothing is divided into various age related categories.

The understanding of these categorizations with their specific needs is important. The activity is designed to enhance the student's ability to analyze the customer's clothing need and objectively place them under the defined heads.

Draw a table as illustrated.

Collect pictures from the internet, magazines or newspapers as per the described headings in the table.

Place them in the drawn table and fill in the details.

Categories	Age	Needs of the child in the age category defined	Paste Pictures of relevant clothing best suited to the needs described
Infants			
Toddlers			
Preteens			

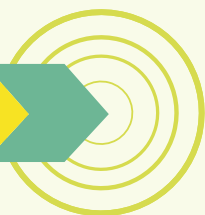



Trims

3.5.1 Introduction to Trims

Trims are functional and decorative details applied to a garment.

Fastenings, like buttons, zippers, velcros, etc. which add utility to a garment are functional trims. Appliqués, ribbons, laces added to the basic garments to increase the aesthetic appeal are called as decorative trims. Pockets, collars and cuffs can also be treated as trims. Appropriate trims can greatly enhance the overall look of the garment and increase its scalability.

Trimming is viewed as a value addition to a basic garment that would increase its pricing. However, random trim application may not only increase the cost of the garment it may also adversely affect the aesthetic appeal of the garment.

Points to be kept in mind for the application of trims on a garment are:

1. Trims should complement the design of the garment.
2. The trim cost should be within the framework of the garment price.
3. The material of the trim should be compatible with that of the garment fabric.

Two design areas that use trims frequently are childrenswear and womenswear lingerie.

Appliqué work and laces are often used on children's clothing as a decorative detail, adding value to the overall look of the garment.

Lingerie is a French word for women's inner wear. Lingerie uses laces, appliqués and special machine edgings to give a delicate feminine look.

3.5.2 Trim Classifications

3.5.2.1 Fastenings

Buttons were invented about 800 years ago. But for centuries people who wore buttons were considered morally loose because they could undress much faster than those who wore clothing with lacings and strapping. Later, buttons became the fashion rage, and they were used both ornamentally and functionally.

Even functional buttons add a decorative element to the garment.



Fig 31: Assortment of buttons



Buttons are available in a variety of sizes, shapes, material, colours and designs. The size of the button is governed by its 'line'. Line gives the diameter of the button. Thus higher the number of line bigger the button.

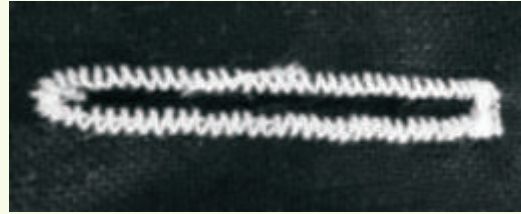

Fig 32: A close view of a buttonhole

Buttonholes are slits made in one of the two parts of a placket through which the buttons slip to close the placket. Button holes can be machine-made, hand-made or bound. Accurate positioning of button and buttonholes is important for functional buttons.

3.5.2.2 Hardware

Hardware refers to the metal fastenings used in luggage and for closures, such as the dog leash clip, hardware snap, buckles and locks. Casual wear trousers, jackets and outer wear apparel often use hardware fastenings as functional and decorative details.

3.5.2.3 Zippers

The zip is a sliding closure applied on straight plackets. It can be used as a functional or decorative element. The zip is available in almost every length and colour, and it can be dyed in almost any shade. Heavy duty industrial zips with contrasting tape and a novelty puller are a popular design detail for children's wear. Delicate, concealed zips with transparent tape are ideal for formal clothes such as evening gowns and dresses.



Fig 33: Nylon zipper with visible teeth

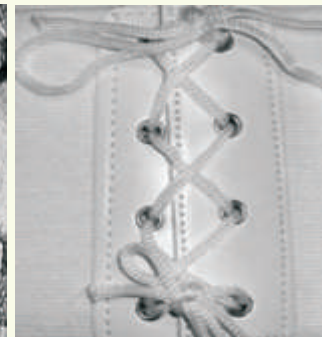

Fig 34: Lacing with rayon cord

3.5.2.4 Lacings

Lacings, like cords or spaghetti straps, can be threaded through metal eyelets set into each side of a placket. Lacings can be used as a design detail to create a cowboy or a peasant look depending on the look desired. Fabric loops are an alternative to eyelets.

Ties are like braids used to secure the opening in a garment. They are adaptable to both casual and formal styles. Ties made from garment fabric are popular on ethnic garments.





3.5.2.5 Linear Trims

Linear trims are decorative stitches applied to seam lines and garment edges. These stitches can be created on domestic sewing machines and are usually the least expensive of trims.

The following are examples of linear trims with the relevant look and styling effect on the fabric or garment:

- ❁ The corded edge: outlines and defines the edge it is stitched on.
- ❁ The corded seam: gives a raised effect.
- ❁ Faggoting: openwork is most effective for straight lines.
- ❁ Multi-needle top stitching: can be used with novelty threads and colours to highlight the seams.

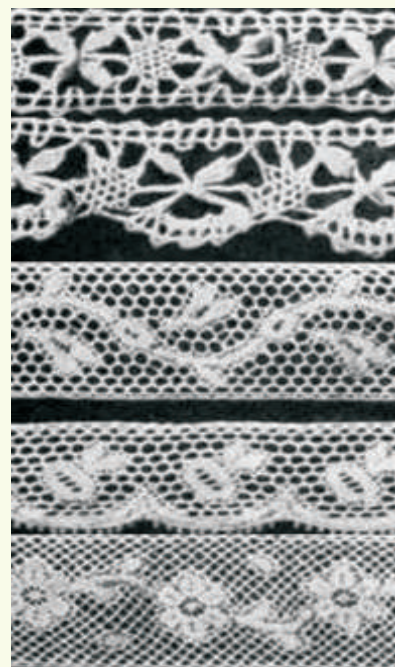

Fig 35: Lace variations

3.5.2.6 Shaped Edges

Shaped edges are essentially decorative, but are used sparingly because they pose technical problems. For example, decorative effects on the hemlines of skirts and pants prevent length alterations. If the hem is raised or lowered, the design impact is lost.



Fig 36: Handmade crochet scalloped edge lace

Some examples of shaped edges are:

- ❁ **Scalloped edge** - curved stitches on the edges of a garment hem, sleeve or a collar.
- ❁ **Lettuce edge** - straight stitches on pleated frills and ruffles, resembles the edges of lettuce leaves.
- ❁ **Crochet edging** - hand crafted lace applied on the edges of a garment hem, sleeve or collar.
- ❁ **Picot edge** - rolled stitches on the edges of light fabrics.



3.5.2.7 Frills or Ruffles

Frills or ruffles are straight or circular shaped fabric gathered along the edge at the hem, on the edge of the garment, or as an area trim.

There are several varieties of ruffles.

- ✿ Straight ruffle variation
- ✿ Lace ruffle
- ✿ Simple straight ruffle
- ✿ Bias ruffle
- ✿ Pleated ruffle
- ✿ Area ruffle



Fig 37: Multiple layered ruffled hem

3.5.2.8 Circular Ruffle

The circular ruffle usually has a smooth, un-gathered edge attached to the seam, and the ruffle makes a graceful, curved edge.

There are several variations of the circular ruffle:

- ✿ Cascade
- ✿ Large ruffle at hem
- ✿ Circular ruffle with wired edge



Fig 38: Grosgrain ribbons

3.5.2.9 Braids, Ribbons and Rick racks

Ribbons and braids are available in a wide variety of colours, widths, weaves and styles. They range from very wide metallic fancies to the classic narrow military braids. Braid or ribbon should be stitched on a garment in a straight line. Rickrack is a curvy zigzag braid usually used in children's garments.



Fig 39: Fabric Patchwork

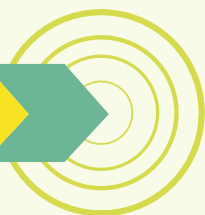



3.5.2.10 Appliqués and Patches

Appliqués are shaped pieces of fabric sewn to a garment with decorative stitches. Usually, appliqués are simple or decorative graphic shapes applied flat on the surface of the base fabric or are stuffed to give a three dimensional effect. This type of trim is particularly suitable for children's wear.

3.5.2.11 Studs

Studs were first used by denim brand: Levi-Strauss as a means of reinforcing the seams on work pants designed for miners in the Californian gold fields. The rivet-fastened pockets and seams are very durable, but today studs can be classified as decorative as well as functional trims. Types of studs include rivet-like nail heads and rhinestones.

3.5.2.12 Heat-Transfer Prints

These trims decorations / prints are heat set on the garments by a machine. The machine applies heat to the printed paper and hence transfers the printed design on the fabric of the garment.



Glossary

- ❖ **Appliqué:** A shaped piece of fabric sewn to a garment with decorative stitches.
- ❖ **Lingerie:** A word from French language for inner wear worn by women.
- ❖ **Button:** A common trim used for the closure of the garment.
- ❖ **Buttonholes:** Slits made in one of the two parts of a placket through which the buttons slip to close the placket.
- ❖ **Zipper:** A sliding closure applied on straight plackets.
- ❖ **Lacings:** Cords, Straps, Braids that can be threaded through eyelets, used to either secure a garment or create a decorative detail.
- ❖ **Linear Trims:** Decorative stitches applied to seam lines and garment edges.
- ❖ **Shaped Edges:** Decorative edgings normally shaped in a curve given to a fabric edge.
- ❖ **Frills:** Straight or circular shaped fabric gathered along the edge at the hem, on the edge of the garment, or as an area trim.

Exercises for Chapter – 5

Fill in the blanks:

1. Trims have and purpose in a garment.
2. Two design areas that use lace trims most frequently are and in womenwear.
3. and are often used on children's clothing as a decorative detail, adding value to the overall look of the garment.
4. is a French word for women's inner wear and at home garments.
5. The size of the button is governed by its
6. are slits made in one of the two parts of a placket through which the buttons slip to close the placket.
7. Metal fastenings used in luggage and for closures, such as the dog leash clips, snaps, buckles and locks are referred to as
8. The is a sliding closure applied on straight plackets.
9. are an alternative to eyelets.
10. are like braids used to secure the opening in a garment.
11. trims are decorative stitches applied to seam lines and garment edges.

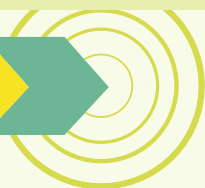



12. or are straight or circular shaped fabric gathered along the edge at the hem, on the edge of the garment, or as an area trim.
13. is shaped pieces of fabric sewn to a garment with decorative stitches.
14. Studs were first used by as a means of reinforcing the seams on work pants designed for miners in the Californian gold fields.
15. and are 2 product categories where trims could be extensively used

Review Questions:

1. Define trims
2. Write short notes on the application of trims in various forms in a garment.
3. How are trims classified?
4. What are linear trims? Explain their usage in a garment with examples.
5. What the 3 points to be kept in mind before application of trims in a garment?
6. Why should Scallop edges be avoided on skirt hemlines?
7. Explain the following terms:
 - ✿ Applique
 - ✿ Picot edge
 - ✿ Zippers
 - ✿ Buttonholes

Activity

Trims add an important attribute to the garments. They are added in a garment to serve functional or non-functional purpose. Based on the requirement, there are massive varieties of trims and laces available in today's market for clothing.

The activity is designed to help the student to understand the applications and importance of different kinds trims.

Collect pictures from the internet, magazines or newspapers and make a folder of fasteners in the three categories of:

- a. Functional fasteners
- b. Non Functional or Decorative fasteners
- c. Trims and laces

Place them in your scrap book and discuss in class.

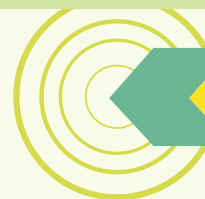



FASHION STUDIES

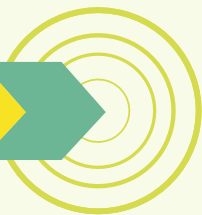



Chapter 4

Basics of Garment Making

4.1 Fibres and Fabrics

Fibres are the basic components of textile fabrics. Each has a unique characteristic that it lends to the fabrics made from it. Although fabric's character can be altered by yarn structure, by the type of weave and also by the finish that is given to the fabric, the original personality is still evident in the final fabric and is important to its uses and its care.

Before this century all the fabrics were made from natural sources. In recent years a plethora of new fabrics have come into the market, which are products of chemical laboratories or, in other words are man-made.

There is a variety of fabrics available in the market; these can be broadly divided into three major categories

4.1.1 Categories

- i) Natural
- ii) Man made
- iii) Blends of natural and man made

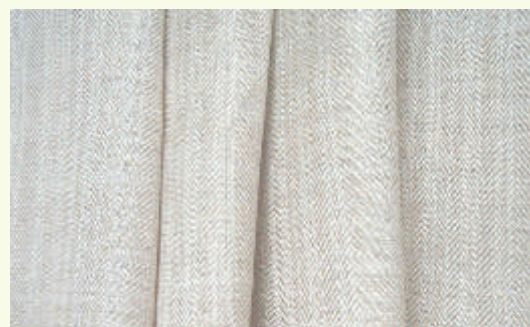
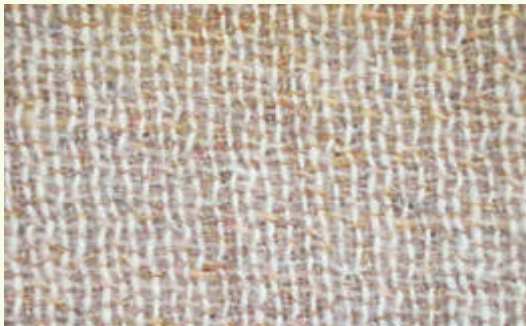



Natural fabrics are further categorized into fabrics that are procured from animals and those, which originate from plants.

The commonly available and used animal fabrics are silk, wool, fur, leather etc. However, some experts do not include fur and leather in textile fabrics technically, as they are skins of animals. On the other hand, some do include them, as they are widely used as an alternative to textile fabrics both for garments and household products. The most commonly available and used plant fabrics are cotton and linen.

4.1.2 Characteristics

Natural fibres have the irregularities and sensitivity inherent in natural things. These contribute to the beauty of natural fabrics. *Advantages:* These fibres, due to their natural character, have common qualities of being absorbent and breathe due to the porous structure. Thus, they are more responsive to climatic changes in temperature and humidity and are hence more comfortable to wear under a variety of climatic conditions. The *disadvantage* of natural fabrics, especially for cotton and linen, which is also an inherent quality, is that due to less elasticity they tend to wrinkle. This is also being overcome with a variety of wrinkle-resistant finishes, though at the cost of some comfort. Mercerized cotton is a common example of wrinkle-resistant finish without the application of chemicals, where cotton fibre is spun at very high tension to produce sheen in the yarn and make it more supple thus making it wrinkle-resistant.

Synthetic fabrics have their beginnings in chemical solutions that are forced through tiny holes into chemical bath or air chamber; these harden into long ropes of fibres that are later woven into fabrics. *Advantages:* All synthetic fibres are elastic hence they are wrinkle-resistant. *Disadvantage:* On the other hand almost all manmade fibres are less porous hence they are uncomfortable in hot and humid weather. Certain synthetics like Nylon are thermoplastic and hence can be moulded at controlled temperature and pressure to create interesting textures and design variations; they are called heat-set designs. An all time favourite of this design is heat set pleats. Japanese designers have explored a lot in this technique and have mastered the art of heat set pleating. This pleating can be done at any stage in fabric production at fibre stage, yarn stage or on the final fabric.

Blended Fabrics are combinations of two or more different fabrics. Usually the fibre present in higher percentage dominates the characteristics of the final fabric, but a successful blend will have desirable qualities of all fabrics. One such successful and popular fabric is Terry cot® which is a blend of 65% Cotton and 35% Terylene.

A common problem with the synthetics is the large number of terms used to identify them. For example, Acrylic may be called Orlon® & Acrilan® as they are the registered trademarks of some companies which generally confuse the consumers. In India, the

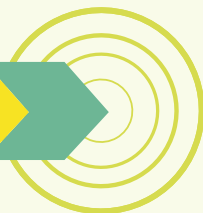



consumer generally recognises the fabrics by the trade names or the common group terms by which a shopkeeper might be referring to them. Another problem is the fact of the common consumer being misled by shopkeepers selling polyester blended silk as Khadi silk and claiming it to be pure silk. The consumer, therefore, needs to learn to identify commonly used fabrics, as most fabrics cannot be identified by their appearance alone. The information on the fabric bolt can be read, as it is compulsory for the manufacturer to print it on the fabric

4.1.3 Underlying fabrics

Underlining

Underlining is a lightweight fabric that is applied to the wrong side of the garment fabric primarily to **give additional strength, support, and durability** to the garment. Underlining also helps to maintain the shape of the garment and to reinforce its seams. An additional benefit of underlining; it will give a degree of opaqueness to the garment fabric. This keeps the inner construction details and stitching from showing through to the outside the garment. Underlining fabrics are made from various fibres, finished in several different hands (soft, medium, and crisp), and available in a wide range of colours. There are also other fabrics, such as organza, tricot, and lightweight blouse and lining fabrics that are not classified as underlining but can serve the same purposes.

(a) Interfacings

An interfacing is a special type of fabric applied to the inside of a garment to give it **shape, body, and support**. Since it is usually a sturdier fabric than is used for underlining, its effect on the garment fabric is more apparent and definite. An interfacing may be applied to the entire garment but is usually applied only to parts, such as collars, front or back openings, lapels, and hems, and to such details as pocket flaps.

Interfacings are made from many different fibres in several weights and degrees of crispness; they may be woven or non-woven. A comparatively new category of interfacings, fusible interfacings, instead of being stitched to the garment fabric, are ironed onto it. Fusible, too, may be woven or non-woven. The wide range makes it possible to choose an interfacing that will be compatible with any type of garment fabric. Two considerations are critical in selecting interfacing: (1) it should complement and reinforce the garment fabric without overpowering it; (2) though the two fabrics need not be identical in fibre content, it is always best that they should have the same care requirements.

(b) Interlining

Interlining is a layer of fabric inserted between the **face or shell and the lining** of the garment. It is similar to batting, a thick layer of fibre designed to provide



insulation to heavy winter jackets. Depending on the application, the materials in this layer can be woven, knitted, or created by fusing fibres together. Silk, wool, and artificial fibres with good insulating qualities are common choices for interlining.

Interlinings can be soft, thick, or flexible. Some are designed to be fused, while others are intended to be sewn to one or both layers of the textile. As an inner lining within textiles, it is used in a number of applications. Though the consumer never sees it, it is the difference between a good winter coat and a great one. Interlining is applied to a garment to supply warmth during wear.

(c) **Linings**

A lining is applied to the inside of a garment to finish it and to hide the garment's inner construction. No matter what type of garment, it is used for the in-dress, coat, jacket, pants- a lining is a luxurious as well as functional finishing touch. Most often made from a relatively slippery fabric, a lining can match or contrast with the colour of the garment. It can even be made of a printed fabric, as long as it does not show through to the outside of the garment. Lining adds a degree of warmth to a garment as well as making it easier to put the garment on and take it off. Though lining fabrics may be of many different fibres, any specific choice should be limited to fabrics that are compatible with the care requirements of the rest of the garment. Besides this, a lining should be sufficiently opaque to conceal the garment's inner construction. Its qualities should be appropriate to the type of garment it is being applied to.

4.1.4 Selection of Underlying Fabric

In considering which of the underlying fabrics are advisable or necessary for the garment being constructed, it is much easier to decide about a lining or interlining than about underlining and interfacing. Lining and interlinings are, in effect, extras added to a garment for comfort and, in the case of lining to conceal the inside of a garment. Neither of these helps in any way, however, to build in or maintain the shape of the garment.

This is done by Underlining and interfacing.

There are two determining factors with that affect the type of underlining:

- (1) The shape or body intended by the garment design
- (2) The support needed in order to achieve that design in the desired fabric.

Generally speaking, the more structured and detailed a design or style is, there greater the need for an underlining and interfacing. The weight of the garment fabric is a factor too the lighter in weight or softer the fabric is the more support it needs.

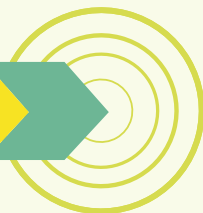



Activity

Collect swatches of fabrics. Create a folder and identify the fabrics collected, also list the fabric content, commercial name and price of the fabrics. This will become a resource guide for you for fabrics.

Fill in the blanks

1. The fabrics can be characterized into _____, _____ and _____ fabrics.
2. The inter lining in the garment is for providing _____ and _____ to the garment.
3. Underlying fabrics are _____ & _____
4. A lining should be sufficiently _____ to conceal the garment's _____ construction
5. Interlining is added in between the _____ and _____ of the garment.

Review Questions

1. Define Fibres. Explain various types of fibres based on their origin?
2. Define advantages and disadvantages of natural fibres
3. Name 2 fabrics that serve the purpose of underlining



4.2 Cutting Preliminaries

4.2.1 Fabric preparation

An essential step before starting to construct the garment is fabric preparation, that is to treat the fabric before cutting it out in order to achieve a better fit and professional look. Different fabrics will need different care and the labels on the fabric bolt will provide information on, whether the fabric is washable, to be dry cleaned, or prove to shrinkable. The label should carry information whether the fabric has been pre-shrunk by the manufacturer or if it will shrink, and if so to what extent. To preshrink washable fabric, simply soak, wash and dry in the same manner as one would after the garment is finished.

To preshrink dry-clean fabrics, use a steam iron and move the iron horizontally or vertically across the grain of the fabric (never press fabric diagonally as this may distort the fabric). After steaming the fabric allow it to dry on a smooth, flat surface until completely dry. (About 4-6 hours). Trims such as zippers and laces etc may also need preshrinking.

Proper fabric preparation is an essential preliminary to cutting. Understanding of the fabric and its properties is since fabric is the most important component of any garment. In weaving, warp or fixed yarns are interlaced at right angles by filler or weft yarns.

Selvedge: The lengthwise finished edges of a woven fabric. Selvedge (self edge of a fabric) is a narrow, firmly woven strip along the length of the fabric.

Grain is the direction in which the yarns are woven. The lengthwise and crosswise threads of a woven fabric used in its construction. The lengthwise grain runs parallel to the selvedge of the fabric. This has the least amount of stretch. The crosswise grain runs perpendicular to the selvedge and has a little more stretch than the lengthwise grain. Crosswise grain is used vertically only to achieve a certain design effect, as in border print placement.

The **Bias grain:** The diagonal of a woven fabric in which a true 45-degree angle is formed. The bias has the greatest amount of stretch. A bias-cut garment usually drapes softly. It also tends to be unstable at the hemline.

4.2.2 Fabric cutting

Cutting of Fabric: Three methods are used for cutting different kinds of fabric.

Tearing is the fastest, but appropriate only for firmly woven fabrics: other types may snag or stretch. **Drawing a thread** is slower, but the most suitable for loosely woven, soft, or stretchy fabrics.

Cutting on a prominent line is a quick, simple method for any fabric that has a strong woven linear design.

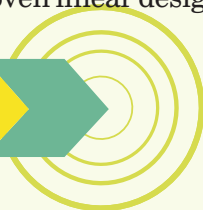



Checking fabric alignment comes next. During manufacture, the fabric may have been pulled off-grain, so that grain lines are no longer at perfect right angles. A garment made with such fabric will not hang correctly, so re-alignment must be done before cutting. Bear in mind that not every off-grain fabric can be corrected, especially those that have water repellent or permanent press finish, or a bonded backing.

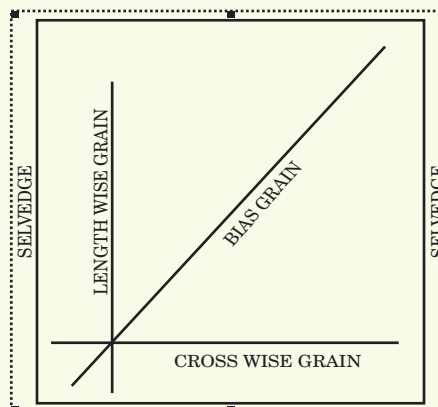

Blocking off-grain fabric

First thing one needs to ensure is that fabric is on grain. Fold the fabric in half lengthwise lining up the ends and selvages. If the fabric is on grain it will lay flat. If it bubbles it is off-grain it needs to be straightened. If not, then one needs to straighten the crosswise ends of the fabric. For correction of 'off-grain fabric', pull it diagonally at the opposite ends. First in one direction then

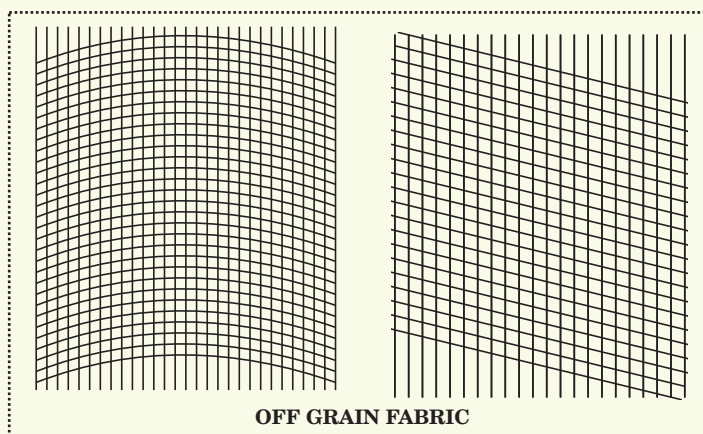

in the other, this process is also known as blocking. For all other woven fabrics, cut into the selvage and gently pull one or two crosswise threads pushing fabric along the threads till the opposite selvage. Then cut the fabric along the pulled thread. Repeat these methods on both ends of the fabric. All fabrics can be straightened except for permanent-finish fabrics.

To straighten slightly off-grain fabric leave it folded lengthwise and pin together the selvages and both ends making sure they line up, then using a steam iron press from the selvage to the fold.

Different fabrics require different methods. For knit fabrics simply cut along a crosswise rib. On striped, plaid, or checked fabric simply cut along a straight crosswise line.

4.2.3 Grain line

Grain line is a line drawn from end to end on each pattern piece to indicate how the pattern should align with the lengthwise grain of the fabric. Which ever direction the grain line is drawn on the pattern, it will always be placed parallel to the selvage on the fabric.



Direction of Grain line

Straight Grain line: For garments to be cut on straight grain, grain line is drawn parallel to the centre front or back of the garment along the length of the piece.

Crosswise Grain line: For garments to be cut on cross wise grain, grain line is drawn at right angle to the centre front or back of the garment or across the garment width.

Bias Grain line: For garments to be cut on the bias, grain line is drawn at an angle of 45° to the centre front or back of the garment.

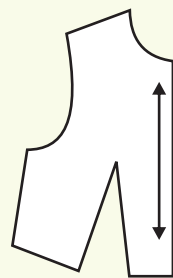

STRAIGHT

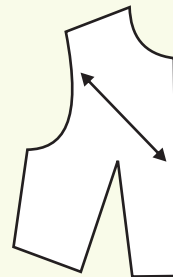

BIAS



CROSSWISE

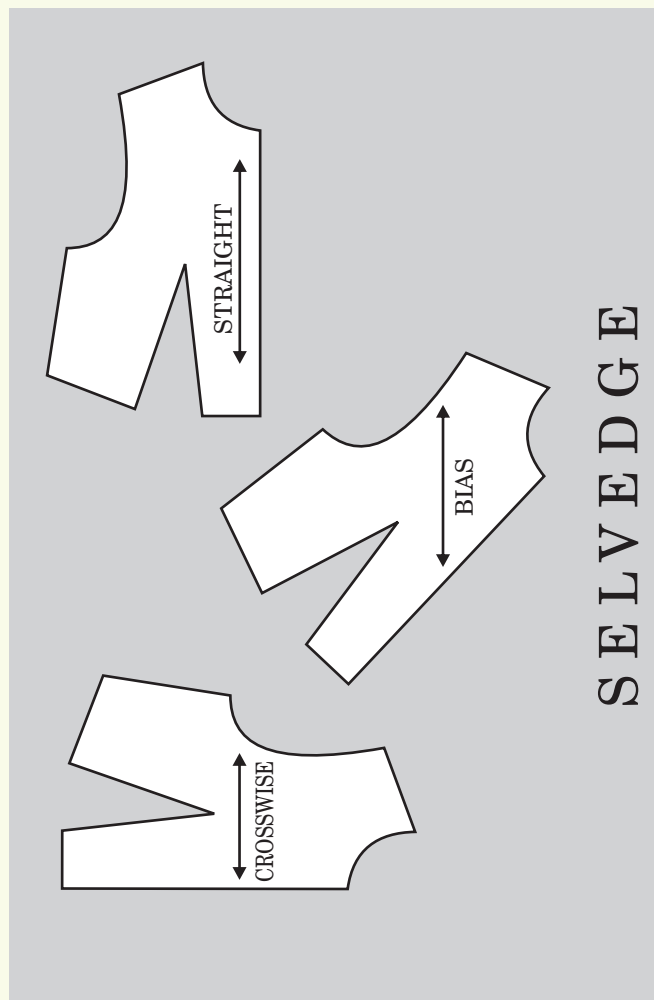

4.2.4 Preshrinking

Some fabrics have the inherent character of being prone to shrinking, like cotton. It is advisable that when sewing these fabrics, care should be taken to check the fabric shrinkage. There is no fixed percentage that can be attributed, to the shrinkage of a

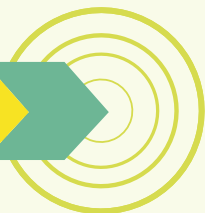



fabric. The fabric characteristics are also determined by the yarn and fabric construction. Hence no single formula can be given for determining the exact percentage of shrinkage.

To **preshrink** washable fabrics, launder and dry it.

It is recommended that cotton fabric be soaked in cold water overnight before cutting. In addition iron fabric well before cutting as any folds retained in the fabric will create a fitting problem later. This technique will take care of shrinkage and also of colour bleeding if required. In case the colour of the fabric runs, put colour fixer, (a number of brands are available in the market or can be fixed with a home mix of a table spoon of salt and half a cup of vinegar in half a bucket of water) in the same water in which fabric is soaked. This is only required for unblended cotton fabric. Woolens should be dry cleaned if one is not sure that they can be hand washed. Silks too should be dry cleaned until one is absolutely sure about the wash ability of the fabric. All synthetic fabrics should be pre-soaked in cold water and well ironed to remove all folds and creases before cutting.

If both shrinking and grain adjustment are necessary, preshrink first, and then re-align grain. Steam iron fabrics that are wrinkled or have crease lines.

4.2.5 Identifying Right Side of Fabric

Right side or face of fabric should be identified before cutting. Often it is obvious, but sometimes careful examination is needed to identify the right side from inside of the fabric. One method of identification is the way fabric is folded-cottons and linens are right side out, wools wrong side out. If fabric is rolled on a tube, face is to the inside. Other indicators are Smooth fabrics are shinier, slicker, or softer on the right sides. Textured fabrics are more distinct on the face for example, slubs may be more outstanding on the right side. Twill fabric is better defined on the right side. Such fabrics often have small irregularities such as extra thick nubs, on the wrong side. Fancy weaves, such as brocade, are smoother on the right side, floats usually loose and uneven on the back. Printed designs are sharper on the right side, more blurred on the back. The selvage is smoother on the right side. Some knits roll toward the right side when stretched crosswise.

The fabric face is generally more resistant to soil and abrasion but you can use the wrong side out if you prefer its look. When there is no visible difference between sides, mark on the back with chalk to avoid confusion.

4.2.6 Folding Fabrics for Cutting

The first step in following a cutting layout is to determine how fabric should be folded, if at all. Precision is vital here. Where selvages meet, they should match exactly. Slippery or soft fabric can be pinned at selvages every few inches. If the material was folded at the time of purchase, make sure the fold line is accurate and re-press it if necessary. When no fold is indicated, lay fabric right side



Pinning

For pinning pattern to fabric, the general order is left to right and fold to selvage, for each pattern piece. Pin fold on grain line arrow first, then corners, and finally edges, smoothing pattern as you pin. Place pieces as close together as possible, overlapping tissue margins where necessary. Even small changes may result in the pieces not fitting into the space apportioned to them.

The efficient way to place pins is diagonally at corners and perpendicular to edges, with points toward and inside cutting lines. (For delicate fabrics, leather and vinyl, in which pins could leave holes, take care to pin within seam allowances.) Use only enough pins to secure fold lines, grain line arrows, corners, and notches. Use of too many pins can sometimes distort fabric, making it difficult to cut accurately. A few pins more than generally used to pin a pattern piece in place, may be needed for slippery or soft fabrics. A firm hand is required to be placed on the pattern to hold it in place while cutting the fabric; this provides adequate control and ensures that fabric doesn't slip.

4.2.7 Marking Methods

Marking-the transfer of significant pattern notations to fabric- is done after cutting and before removing pattern. Common marking methods and their typical uses are discussed below. In general, any device can be used provided it makes a precise, clear, mark without disfiguring the material. Always pre-test a fabric swatch to be sure marks show up clearly and can later be removed.

Using a **tracing paper and wheel** is a fast method that works best on plain, opaque fabrics. It is less satisfactory for multi-coloured fabrics, and not recommended for sheers as marking shows through to the right side. It is preferred to other methods for its convenience, but the wheel can rip tissue, thus limiting the reusability of a pattern. While tracing, keep cardboard under fabric to prevent marring of the surface beneath. Use serrated wheel for most fabrics, smooth wheel for those that are delicate, hard to mark, or napped. With fabric folded wrong sides together, both layers can be marked at once using double -faced paper or two sheets back to back. With fabric right sides together, layers are marked one at a time. Only dots are registered, but these can be connected, if desired, after pattern is removed.

Tailor's chalk is also a quick marking device. For this use ruler and chalk, regular or wax type. The first tends to rub off easily; the wax type is more durable, but cannot be removed from some fabrics.

Thread Tracing is done on fabrics which are delicate and slippery to mark the seam allowances, grain, dart, centre front, centre back, waist etc. it is to be done on right side of the fabric. It has an advantage that it does not leave marks and is very effective for jackets dark colour fabrics

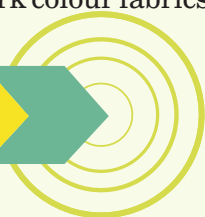



4.2.8 Pattern Layout

It takes time and effort to fit together all the a pieces of pattern. It is like playing a giant puzzle. The game is to place all the pattern pieces on grain in such a manner so as to be able to use the entire width and the length most economically.

Place the fabric on a flat surface. Line up its straightened edges with the straight edges of the cutting surface. Place the pattern in position. Start with one end of the fabric. Support the weight of the cloth at the other end of the cutting area. Always place the largest piece first, then the ones that may need to be cut on fold. Fit in the smaller pieces. Fit in the shapes against each other, locking them whenever possible. This saves a lot of fabric. Arrange the pattern pieces in such a manner that if any fabric is left, it is in one usable piece, either at an end or middle.

The pattern pieces have to be laid out in such a way that it takes into account **directional properties** of fabric, such as fabric design and fabric grain. **Mitering** is the perfect matching of check or stripes and other directional prints on the side seam, centre back and centre front seam or any seam that might be running across the garment such as a yoke or waistline seam. This might require more fabric consumption and great deal of time and effort, for a perfectly mitred garment is a joy and pride of a designer and master tailor.

DUNGAREE PATTERN LAYOUT
ON FOLD

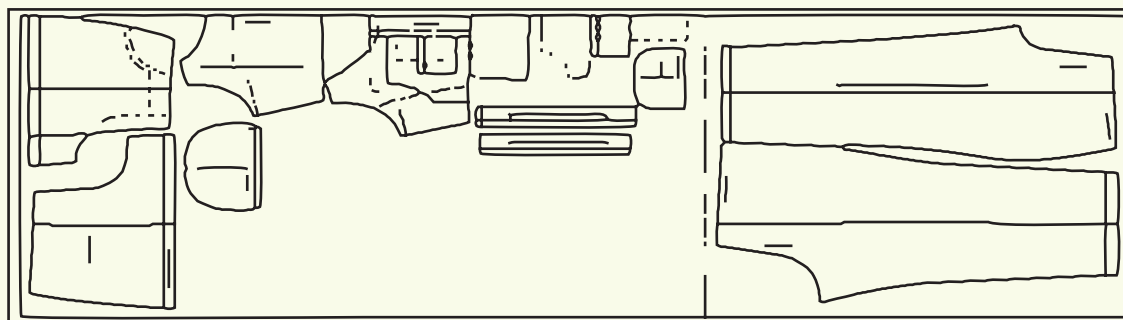

S E L V E D G E

4.2.9 Computerized Marker Making

All the pattern pieces of the garment are either digitized or drafted on the computer and a lay of the garment is made. A rectangle of the dimensions of the fabric is created and the pattern pieces are placed on it in exactly the same manner as one would on a fabric keeping in mind whether a piece is to be cut on fold, on bias or on a cross grain.

This exercise ensures that more scientific, precise and accurate fabric calculation is done.



Cutting

For accurate cutting results, always keep fabric flat on the cutting surface, and use proper shears and techniques. Bent handle shears help in keeping fabric flat. These are available in four blade types- plain, serrated, pinking, and scalloping. Plain and serrated blades can be used interchangeably, but serrated blades are designed to grip knits and slippery fabrics. Pinking and scalloping shears should be used only for seam finishing. A 7 or 8 inch blade will suit most cutting situations: a 9-inch length is better for heavy fabrics. Be sure that blades are sharp; dull ones will chew fabric. If the scissor action is stiff, adjust the blade screw slightly or apply greaseless lubricant.

4.2.10 Cutting Special Fabrics

Certain fabrics involve special considerations in pattern selection and layout. A fabric can fall into one or more problem categories.

Directional Fabrics

Directional fabrics are so called because they must be laid in **one direction** for cutting, example are napped fabrics (with pile or brushed surfaces); designs that do not reverse (one-way designs): and surfaces that reflect light in varying ways (shaded).

To test a **napped fabric** (one with pile or brushed surface) for direction, run a hand over it. It will feel smooth with nap running down, rough with nap running up. **Short naps** (such as corduroy) can be cut with nap running up for rich colour tone or down for a frosty effect. The same is true of shaded fabrics. Long piles or shags should be cut with nap running down for better appearance and wear, one-way designs are cut according to the natural bent of the design, or the effect desired.

Because all pattern pieces must be laid in one direction, a crosswise fold cannot be used.

Plaids, Stripes and prints

Even and Uneven Plaids

A plaid is a design of woven or printed bars that intersect at right angles. The arrangement of these bars may be even or uneven. A four sided area in which the colour bars form one complete design is called a **repeat in half**, first lengthwise, then crosswise. A **plaid** is even when colour bars and intervening spaces are identical in each direction. Stripes also may be even or uneven; each type is handled by the same methods as a corresponding plaid, the exception is a diagonal stripe.

Plaids, either **square or rectangular**, are the easiest to work with, though a rectangular plaid is somewhat more difficult to match where seam is on bias. An even plaid is suitable for a garment with a centre opening or centre seams, also for one that is cut on the bias

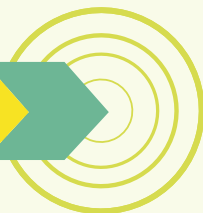



Uneven plaids require extra thought and care in layout planning and have fewer style possibilities. When plaid is **uneven** crosswise, pattern pieces must be laid in one direction, like napped fabrics, when plaid is uneven lengthwise, the repeats do not have a centre from which the design can be balanced out in both directions, and so the design goes around the body in one direction only. Placing a dominant vertical bar or block at centre front and back can establish a type of balance, however. Avoid design with centre seams or kimono or raglan sleeves. An exception can be made to these precautions when a plaid fabric that is uneven lengthwise is reversible. In this case, the pattern should have centre seams, or they must be created. Plan the layout so that the design reverses itself to each side of the centre seams. This is accomplished by cutting each garment section twice, with printed side of the pattern facing up, and using wrong side of fabric for half the garment.

When plaid is uneven in both directions, the same considerations apply as for plaids that are uneven lengthwise plus the need to lay all pattern pieces in one direction as **for napped fabrics**.

Diagonals

For diagonals, avoid any pattern and design with centre seams, long diagonal darts, gored/panelled skirt, collars that are required to be cut on a fold, or even a V-neckline.

Here the wrong side of the fabric is used for half the garment; diagonals are then balanced. In chevron or cutting a plaid, the stripe can also create V-shaped seams. Chevrons can also be created by cutting a plaid, stripe, a other geometric on the bias. To work this way, a design must be even lengthwise.

Diagonals should be cut from a single layer-each pattern piece pinned once with printed side up, once with printed side down.

Unusual Prints

Fabric with a large motif requires careful placement, and sometimes matching, of the design. A precise motif, such as a diamond, must be cantered and matched just like a plaid. To decide placement, drape fabric over your figure before a full-length mirror and try various approaches. If the garment has centre seams, motifs might be placed opposite one another an equal distance from the centre. As a rule, though, the asymmetrical balance is more pleasing. In any case, do not place motifs directly on the full part of bust or buttocks. Another point to remember: a large scale print is often a one-way design, in which case pattern pieces must be laid out as for directional fabrics.

Border Prints

Border print fabric is one with a marginal design running lengthwise along one edge. It can be used in two ways. One is to run the border vertically, placing it to each side of





centre front and/ or centre back seams. The other, more usual way is to place the border at the garment hem. For the latter, major garment sections are cut on the crosswise grain (with new grain line arrows drawn perpendicular to the original ones). If the garment being cut this way has no waistline seam, its entire length must fit on the fabric width, leaving little or no hem allowance.

Activity

Collect swatches of fabric which will require special care of cutting a garment. Create layouts of sample fabrics. Place them in your folder and identify the problems these fabrics can have, also list the shrinking and aligning methods. This will become a resource guide for you for the fabrics.

Fill in the blanks

- The fabrics should be _____ to ensure that the garment doesn't _____ after being stitched.
- The methods of marking a fabric are _____, _____ and _____.
- For jackets _____ is the best method of marking
- Napped fabrics can be marked by _____ on the _____ of the fabric.
- The _____ & _____ fabrics are more distinct on the right side of the fabric.
- Care should be taken to lay special fabrics like _____, _____, _____ & _____ in _____ only.
- A _____ is even when _____ bars and intervening _____ are identical in _____ direction.
- When plaid is _____ in both directions, the same considerations apply as for _____ fabrics.
- _____ prints are generally placed at hems.
- Computerized marker ensures that the most _____, _____ and _____ fabric _____ is done.

Review Questions

- What is a fabric grain?
- What are the three kinds of fabric grain?
- Define Mitreing.

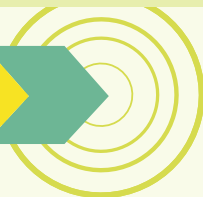



4.3 Placket

A placket is an **opening** in the upper part of trousers or skirts, or at the neck or sleeve of a garment. Plackets are almost always used to allow clothing to be put on or removed easily, but are sometimes used purely as a design element. Modern plackets often contain fabric facings or attached bands to surround and reinforce fasteners such as buttons, snaps, or zippers.

In modern usage, the term placket often refers to the double layers of fabric that hold the buttons and buttonholes in a shirt. Plackets can also be found at the neckline of a shirt, the cuff of a sleeve, or at the waist of a skirt or pair of trousers.

Plackets are almost always made **of more than one layer** of fabric, and often have interfacing in between the fabric layers. This is done to give support and strength to the placket fabric because the placket and the fasteners on it are often subjected to stress when the garment is worn. The two sides of the placket often overlap. This is done to protect the wearer from fasteners rubbing against their skin and to hide underlying clothing or undergarments.

A button front **shirt** without a separate pieced placket is called a "French placket." The fabric is simply folded over and the buttonhole stitching secures the two layers (or three layers if there is an interlining). This method affords a very clean finish, especially if heavily patterned fabrics are being used. This method is normally only used in stiff-fronted formal evening ("white-tie") shirts. However, the normal, separate placket on a shirt gives a more symmetrical appearance.

If the buttons are concealed by a separate flange or flap of the shirting fabric running the length of the placket, it is called a "fly front." The inner placket of a fly front shirt can be made as a less constructed French placket or as a fully constructed regular placket

Plackets

A placket is a finished opening in a garment section. Placket should be designed and styled in sufficient length to permit ease and convenience of dressing. Placket openings are used on sleeves to allow expansion of the narrow end and to provide room, when the cuff is opened. They are used on front or back neckline opening instead of a zipper. Plackets are planned as extension for placement of buttonholes, snaps and other fasteners.

The type and length of placket selected depends on:

- ❁ Placement of placket.
- ❁ Function of placket.
- ❁ Style and design of garment.

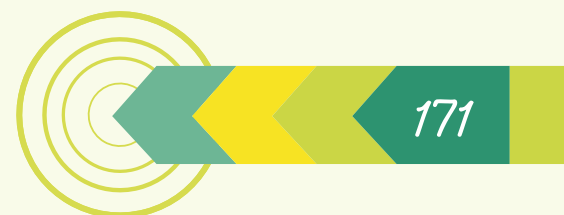



- ✿ Use of garment.
- ✿ Type and weight of fabric.
- ✿ Care of garment.
- ✿ Method of construction.

4.3.1 Continuous Placket

This type of placket is easy to make and serves as the basis for a number of variations. This one piece placket is widely used on cuffed sleeve openings to permit the hand to fit through sleeve circumferences, bloomers, children's' dresses, and on skirts and trousers, where zipper application would detract from appeal of the garment and as a neckline opening alternative to other fasteners or closures.

Pattern Piece Required:

Cut the pattern piece for length of the piece, take double the length of the finished placket opening and add 1" extra. (The 1" extra length of the binding strip is for emergency only. If measurements are accurate and the placket is properly made, this amount should be cut off after the binding is stitched in place.) The width of the piece will be twice the width of finished placket facing (which is usually $\frac{1}{2}$ " for 1 side) plus two times seam allowances (which usually is $\frac{1}{4}$ ")

CONTINUOUS PLACKET

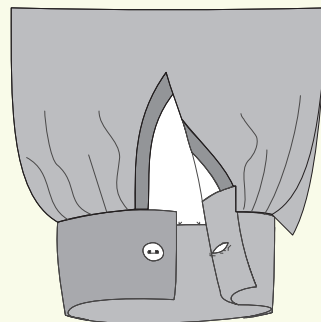

PATTERN PIECES

2 X length of finished placket + 1"

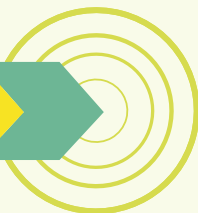
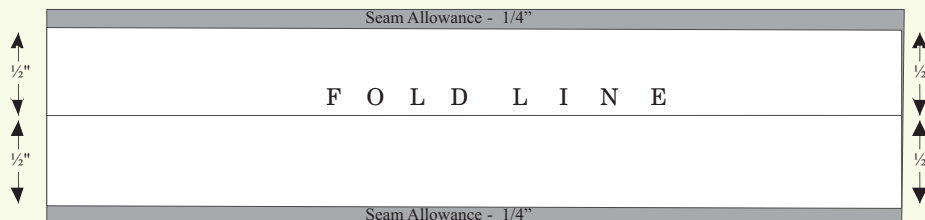



Steps of Construction

1. Place the right side of the placket on the wrong side of the sleeve opening and start stitching near the edge leaving a distance of $\frac{1}{4}$ ". As you come in the centre of the placket, maintain $\frac{1}{4}$ " seam allowance of placket piece and reduce the allowance of the garment piece. Take care so that no pleat formation takes place at this point.
2. Fold the allowance (other side) of the placket and place it on first stitching line. Then stitch in place from right side of the sleeve. Take care that stitching at the back is the same i.e. if it is on top, it should be maintained on top throughout and if it is in ditch then maintain it throughout. In good quality plackets, this seam is on top at the back.
3. From wrong side of the sleeve, stitch both the upper and under of the placket, 2 to 3 times diagonally (at 45°) near end. This is known as Bar Tack.

Continuos Shirt Placket

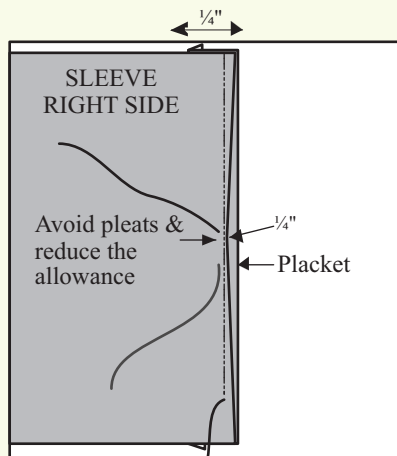

Step-1

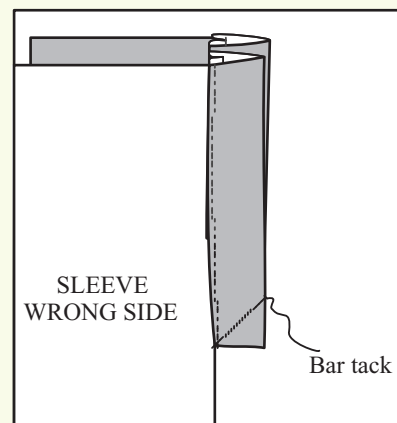

Step-2

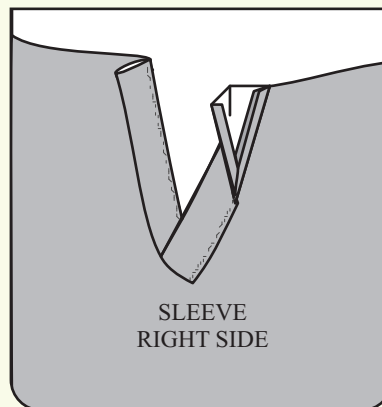

Step-3



4.3.2 Simple Shirt Placket

Two pattern pieces are required one for the upper part and other for the under part.

Upper Part

Trace the bodice till centre front line. Mark the extension; which is taken as half the button + 1 cm i.e. Radius of the button + 1cm = extension. Or it is taken as the diameter of the button. Otherwise a standard measurement of $\frac{1}{2}$ " or $\frac{3}{4}$ " is taken for men's shirts.

The line of extension is the fold line. After this a standard facing of $1\frac{1}{2}$ " is made, an allowance of $\frac{1}{4}$ " is then taken. Turn the allowance towards wrong side of the facing. Then turn fold line towards wrong side of the garment piece. (If facing has to be aligned to the selvedge when placed on fabric, then no seam allowances is taken). Cut out the pattern.

Under Part

Flip the pattern horizontally, trace it. Under part is made in the same way as you make the over part the difference being the facing, which is 1". Otherwise stitching line of under part will be visible on the front of the placket.

SIMPLE SHIRT PLACKET

PATTERN PIECES

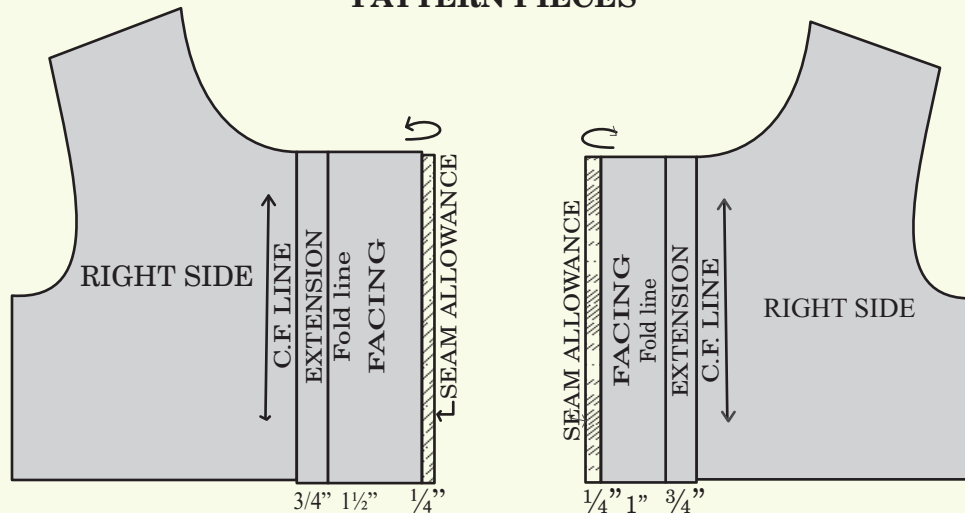

Steps of Construction

Upper Part

1. Trace the pattern on the fabric and mark the position of the lines.
2. Turn the allowance towards the wrong side of the fabric. Turn the facing also in the same way from fold line i.e. towards wrong side of fabric.
3. On the wrong side of fabric, machine stitch on the edge of facing as illustrated.

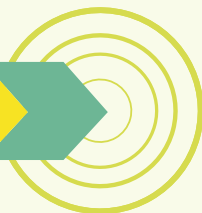



Under Part

1. Trace the pattern on the fabric and mark the position of all lines.
2. Turn the allowance towards wrong side of the fabric. In same way turn the facing also.
3. From the wrong side of the fabric, machine stitch on the edge of the facing as illustrated.

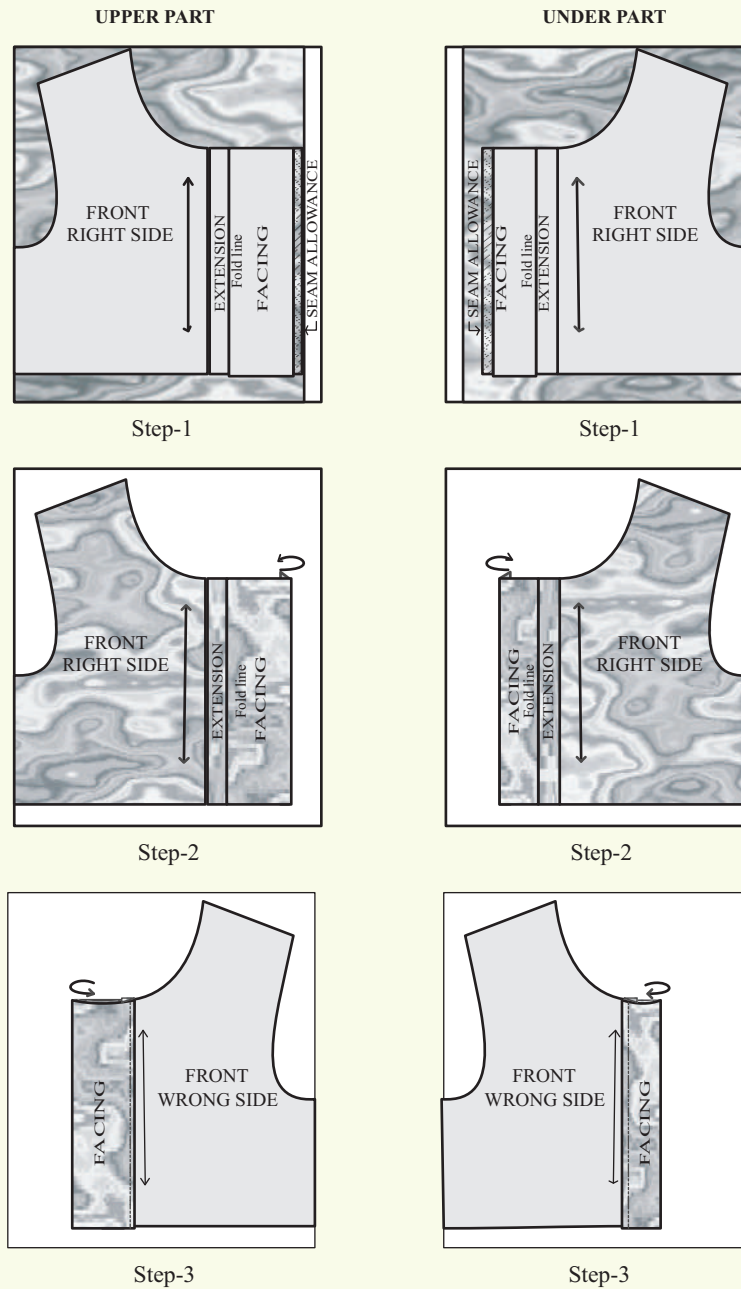



4.3.3 Shirt Placket with Facing

The shirt band/the strip on the right side of shirt front in which the buttonholes are made, eliminates the need for facing. An extended self-facing is used on the left front. The finished shirt band is 1½" wide but construction techniques vary depending on the fabric and style of the shirt.

Pattern pieces required

Under Part

Trace the bodice and make extension of ¾" which is half of finished placket. Then give an allowance of ¼".

Facing

A straight strip of the length same as placket opening is taken, mark ¼" seam allowance on one side and ½" seam allowance on the other side.

Under Part

Flip and trace the other half of bodice and mark extension of ¾" and facing of 1" then mark the seam allowance of ¼".

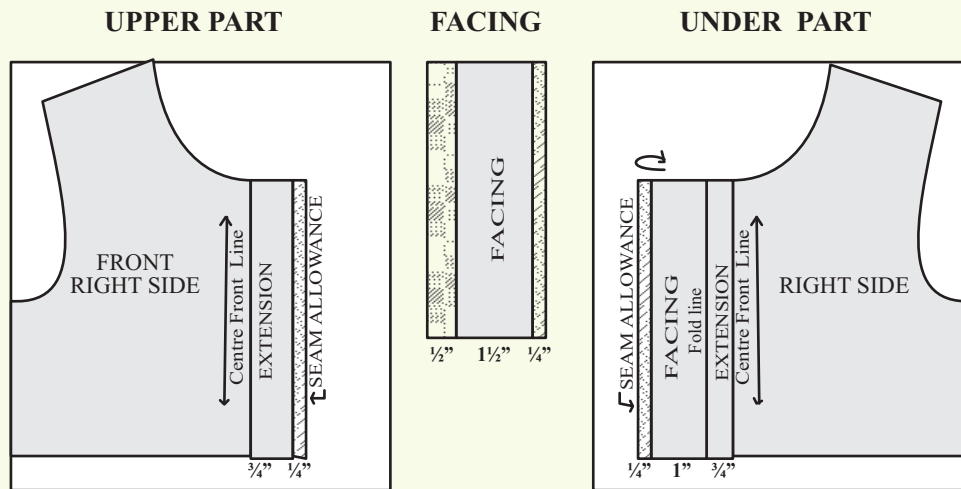

STEPS OF CONSTRUCTION

Upper Part

1. Place right side of the facing over wrong side of garment piece and then stitch leaving the ¼" allowance near edge.
2. From right side of the fabric, turn facing towards right side. Press the seam allowance (½") of facing towards wrong side of facing. Iron in place.
3. Leave allowance of ¼" from both the sides and stitch in place from right side.

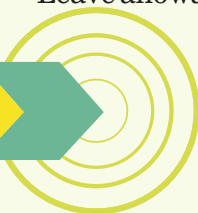



Under Part

Trace the pattern for under part on the fabric. Fold the seam allowance of the facing towards the wrong side of the fabric. Again turn this facing towards the wrong side of the fabric, stitch in place.

(For diagram refer steps of construction for under part of simple shirt placket.)

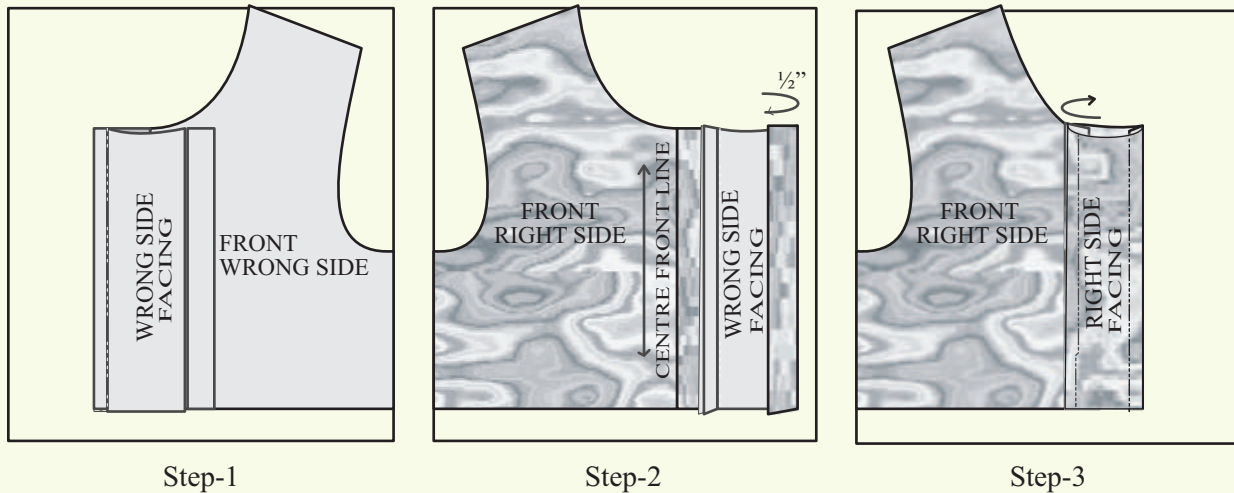

4.3.4 Buttons Placement

The button extension is equal to the width of the button. As a general rule, the neckline of the front bodice is lowered by $\frac{1}{4}$ " at the centre front for comfort, whenever a basic neckline is required. The first buttonhole is placed on centre front, down from neckline an amount equal to the width of the button. This ensures that the button will not extend into the neck. Placement of the last button hole depends on the need of the garment. The rest of the button holes are marked on the even division between the first and the last. It is a good idea to place a button close to the apex or bust point, this ensures that the garment does not gape open at centre front due to movement which may cause a pull on the bust.

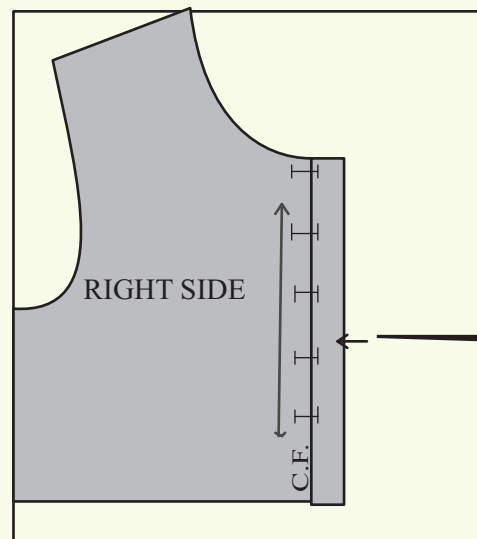

The size of the button hole equals the width of the button plus $\frac{1}{8}$ " for the button to go in easily. The button hole is marked so that width of the button is on the garment side of the centre front and extra $\frac{1}{8}$ " is on the extension.



Activity

Collect pictures of garments with different kinds of openings, identify the fasteners used. Place them in your folder and identify the buttons and other trims used for fastenings. This will become a resource guide for you for the fasteners.

Fill in the blanks

- The placket is a _____ given to the garment _____.
- Placket should be _____ and _____ with sufficient _____ to permit movement.
- _____, _____ and _____ are kind of plackets.
- The size of the _____ determines the size of button hole and width of _____.
- The first buttonhole is placed on _____, _____ from neckline an amount _____ to the _____ of the button.



4.4 Neckline Facings

A facing is the fabric used to finish raw edges of a garment at such locations as neck, armhole and front and back opening. There are three categories of facings: Shaped facings, extended facings and bias facings.

A facing is shaped to fit the edge it will finish, either during cutting or just before application. A "shaped facing" is cut out, using a pattern, to the same shape and on the same grain as the edge it will finish. A "bias facing" is a strip of fabric cut on the bias so that it can be shaped to match the curve of the edge it will be applied to. After a facing is attached to the garments edge, it is turned to the inside of the garment and should not show on the outside.

In order to reduce bulk, both shaped and bias facings can be cut from a fabric lighter in weight than the garment fabric. As the extended facing is cut as one with the garment, garment and facing fabric are always the same but some times may vary according to the design.

NECK LINES

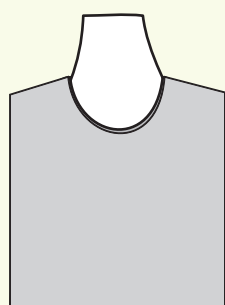

BIAS BINDING

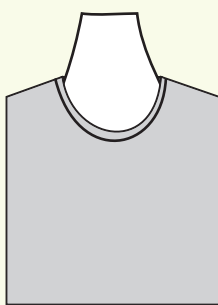

BIAS FACING

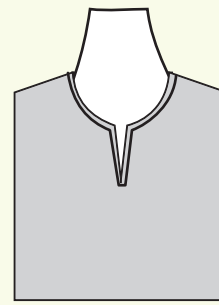

SHAPED FACING

4.4.1 Bias Strip

Bias strip is prepared as a strip of matching or contrasting fabric. In construction it is used to conceal, finish and strengthen seams and raw edges or as a substitute for facings. Bias may be used as decorative binding, piping, or tubing. Bias for binding, piping and tubing is a true bias and is defined as the diagonal line established by a 45° degree angle, intersecting length and cross grain of a square. The bias of the fabric offers the maximum stretch, flexibility, and elasticity needed to conform to a curved edge.

Bias may be self-prepared, specially manufactured for industry, or commercially prepared and purchased in retail stores.

Commercially prepared, pre-cut and folded bias bindings are also known as bias tape or "bias fold" they are available in a variety of width and placement of bias selected depends on:

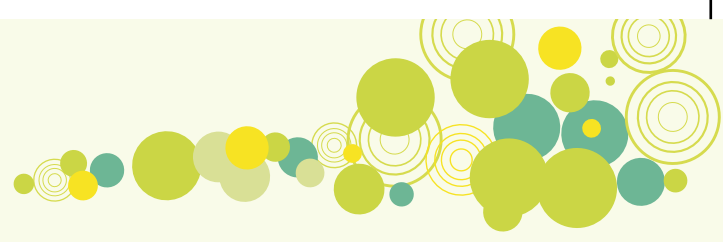

- ❁ Style and design of garment
- ❁ Type of garment
- ❁ Use of garment
- ❁ Care of garment
- ❁ Choice of fabric
- ❁ Method of construction
- ❁ Availability of machines and attachments
- ❁ Procedures for production

4.4.2 Preparation of Bias Strip

Steps of construction

- ❁ First of all find the true bias of the fabric by folding fabric with lengthwise grain parallel to the crosswise grain. The fold edge is the true bias.
- ❁ After locating true bias, draw the width and the desired number of strips needed for desired length of bias and then cut it.
- ❁ Many times the bias stripes are not long enough to complete a continuous sewing step. Adequate number of strips must be joined before starting to sew bias binding or facing. Now Place the cut out bias strips at right angles, right side facing right side.
- ❁ Stitch bias strips with a $\frac{1}{4}$ " seam allowance at angles.
- ❁ Continue to join bias strips as needed for the desired length. Press all seams open and snip extended points.

Once the strip is ready it can be applied on the neckline

4.4.3 Neckline Finished with Bias Binding/Extended Facing

Bias binding is used to finish and strengthen raw edges and also to add a decorative trim to garment. In some case it may replace a facing at the neckline, sleeve or armhole edges.

A standard bias strip is 1 to $\frac{1}{2}$ inch wide is required (either in the same or contrasting colour of the garment). A commercially prepared double fold bias tape can also be used.

Steps of Construction

- ❁ Place the garment on sewing table wrong side up. Now place the bias strip on the garment with right side facing wrong side (of garment), matching both the raw edges.

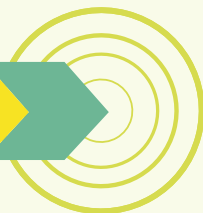



- + Stitch with a $\frac{1}{4}$ " seam allowance.
- + Fold the bias strip over $\frac{1}{4}$ " and press down.
- + Fold bias binding over along stitch line and press down.
- + Fold bias strip over Wrong Side of garment just covering first stitch line.
- + Slip stitch along the edge of bias binding.

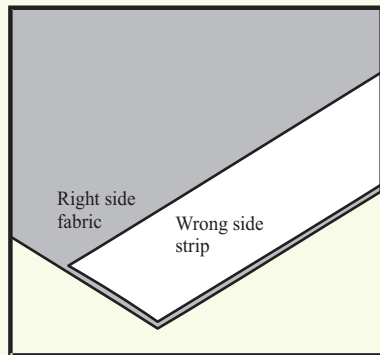

Step -1

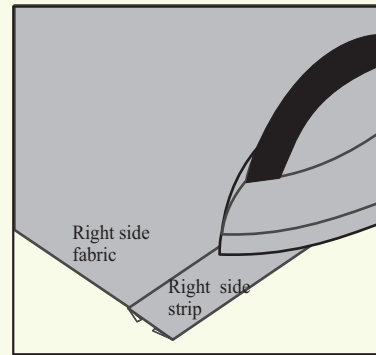

Step -4

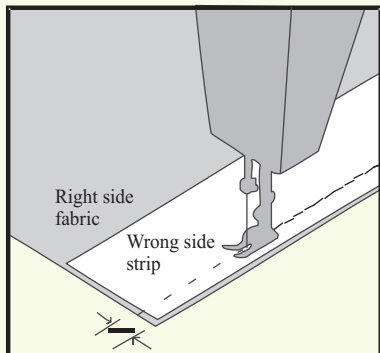

Step -2

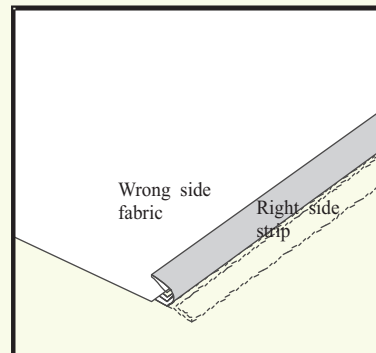

Step -5

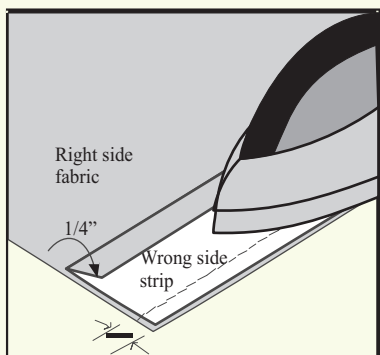

Step -3

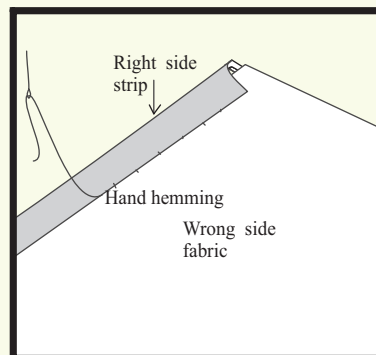

Step -6



4.4.4 Neckline Finished With Bias Facing

A bias facing is a strip of fabric cut on the bias, which is attached to the garment neckline so that it can be shaped to match the curve of the edge it will be applied to. After a facing is attached to the garment, it is turned to the inside of the garment and should not show on the outside i.e. right side of the garment. (To make bias strip refer steps of construction for the preparation of bias strip)

The finished width of bias facing should not be more than $\frac{1}{2}$ ".

Steps Of Construction

- ❁ Face right side of bias strip to the right side of the garment neckline. When applying the binding, fold back the starting end $\frac{1}{2}$ " and align the fold with the garment seam line. Pin binding in place and stitch to within 3" of starting point.
- ❁ Trim away excess binding at this end to $\frac{1}{2}$ " beyond fold of starting end. Lap this end over the beginning fold and stitch the rest of the way across, through all thicknesses. When the binding is turned, the end folded first will be on top; stitch or slip stitch it with the other end.
- ❁ Clip the curved seam allowance.
- ❁ Open the facing away from the garment Press all seam allowances towards the facing. To keep facing from rolling to outside of garments, the seam should be under stitched with facing and seam allowance extended away from garment. Stitch from right side close to neck seam line, through facing and seam allowance.
- ❁ Turn the other edge of the facing towards its wrong side. Press and slip stitch.

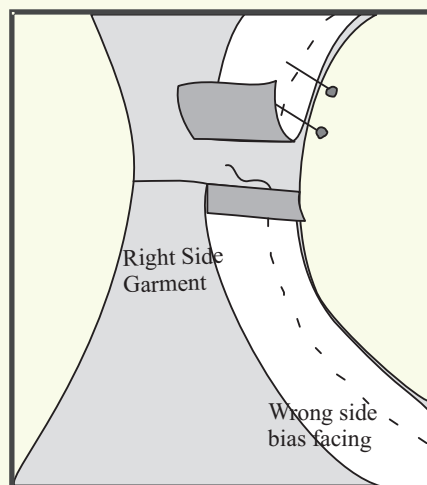

Step -1

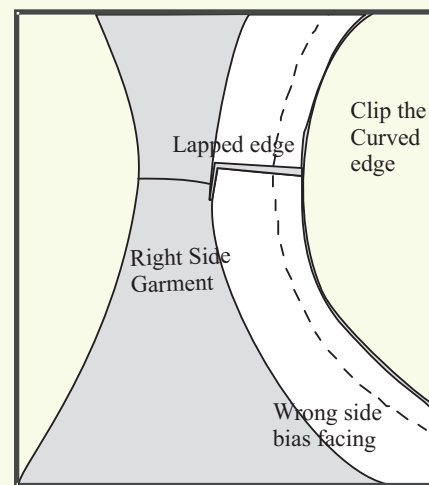

Step -2

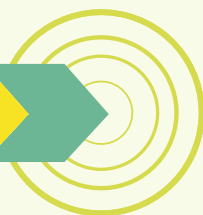

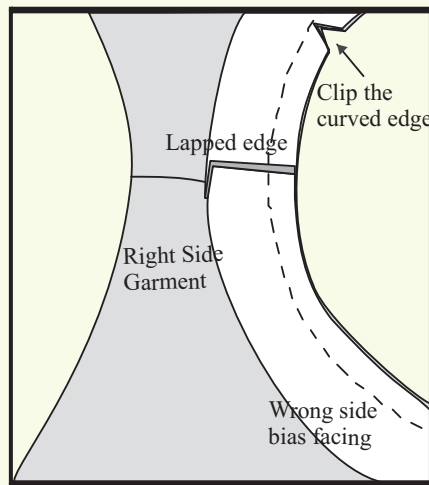

Step -3

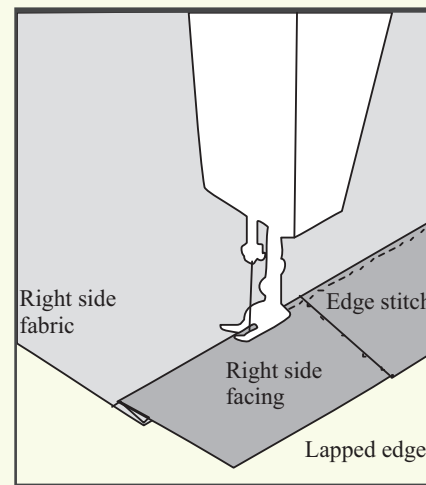

Step -4

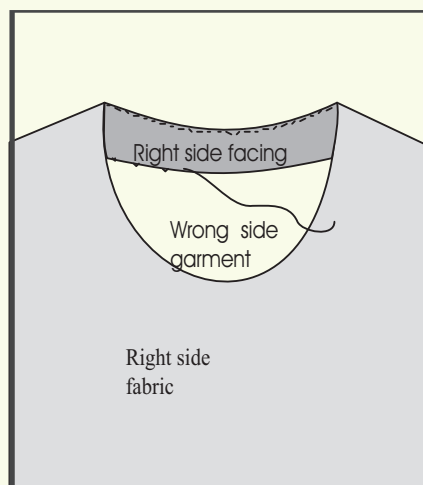

Step -5

4.4.5 Neck Line Finished With Shaped Facing

A neck line shape which is finished with shaped facing i.e. instead of finishing raw edges of fabric at neckline with bias strip as used earlier, it is finished with a facing which is of the same shape as the neckline.

Steps of Construction

- ❁ Interface the wrong side of the facing of both front back.
- ❁ With right side together and the markings on matched seam, the front facing sections to the back facing sections at shoulders. Press seam flat as stitched then open.



- ❁ Keeping seam allowances open, tailor edge finish the facing by turning under 1/8" press. Stitch close to folded edge.
- ❁ Right side together, matching, notches, markings and seam lines, pin facing to neck and machine.
- ❁ Trim diagonally across cross seam allowances at shoulders. Clip curved seams, also slash the opening at front neckline and clip the corners.
- ❁ Place seam wrong side up, using the tip of the iron press seam open.
- ❁ Turn facing to inside of garment, allowing seam line to roll inside slightly, now top stitch at a distance of 1/4".

Steps of Construction

Preparation of facing

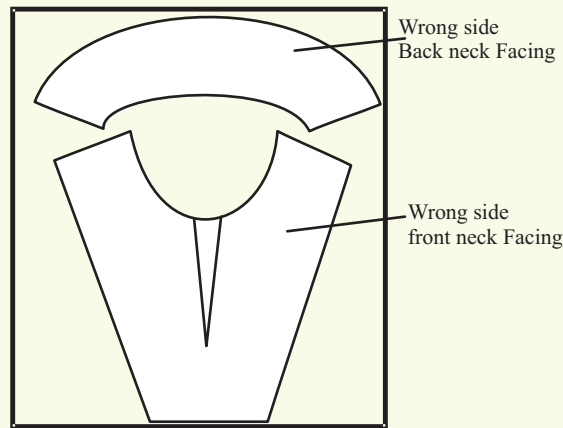

Step -1

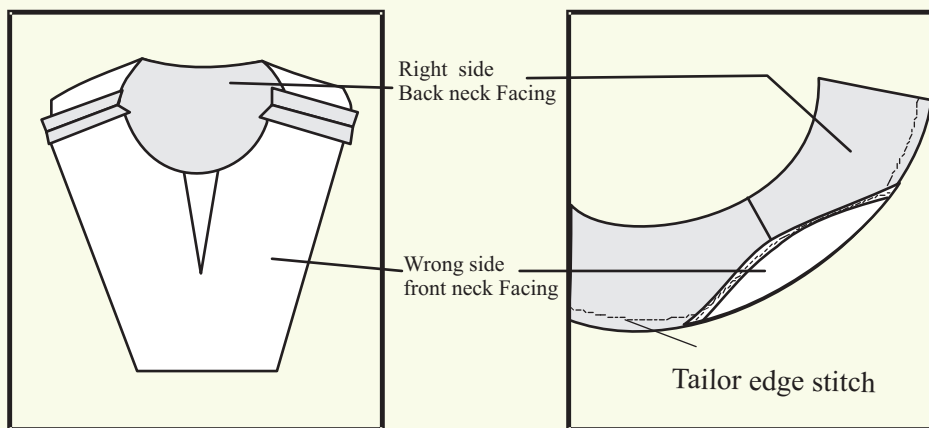

Step -2

Step -3

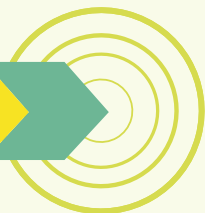



Steps of Construction

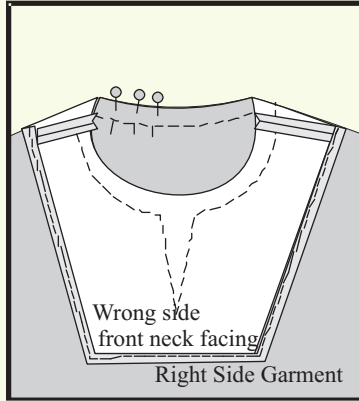

Step -4

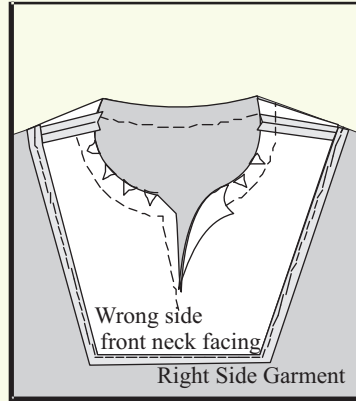

Step -5

Steps of Construction

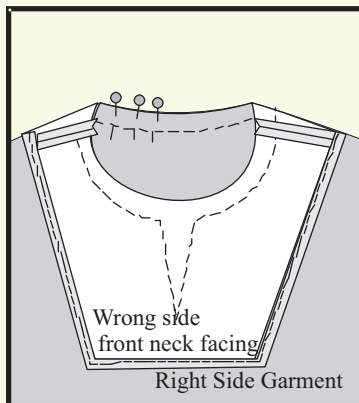

Step -4

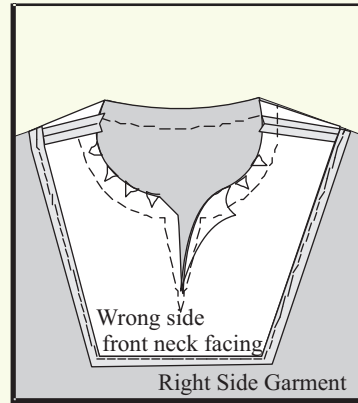

Step -5

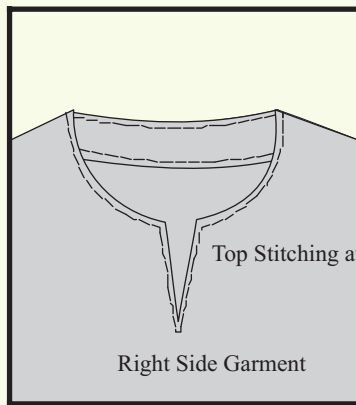

Step -6



Activity

Collect picture of garments with different kinds of necklines, identify the finishing used. Please them in your folder.

Fill in the blanks

1. The neckline can be finished by _____ & _____ facing.
2. A sari blouse is finished by _____ which is very rarely seen in garments in western countries.
3. A true bias can be found by _____ the fabric in _____.
4. Shaped facing is cut from _____ the pattern on the _____ which needs to be finished.
5. Bias binding may be _____, specially _____, or _____ prepared.

Review Questions

1. What is the function of a Placket in a garment? What are the factors to be kept in mind while selecting a placket opening?
2. What is a French Placket?



4.5 Sleeve Attachment

Garments today are designed with a wide variety of sleeves, which add greatly to the look and the method of construction. A garment for example, may have armholes that are merely finished, producing a sleeveless look or it may have sleeves, either set-in or raglan that are separately made and attached to the garment. Another possibility is that kimono sleeves are cut as extensions of the main bodice.

The armscyes on most sleeveless garments are cut to comfortably encircle the arm with upper edge resting at shoulder point. Garments are sometimes designed with wider than usual shoulder widths that drop over the shoulder to create a little cap. Others are styled with narrow shoulder width's that results in a larger and more angled armhole, and something of a halter effect.

Set-in sleeves are the most widely used type. As the name implies, this sleeve is actually set into the armhole edge or cap, may be slightly rounded or fully gathered, the length long or short, the bottom tapered, flared or gathered to the armscye the standard round armhole in sleeves is designed with a slightly rounded cap. Ideally sleeves should fall in a smooth curve from the shoulder edge with no dimpling or puckering. To achieve this, the sleeve cap curvature must be carefully eased into the armscye.

To achieve success with any garment, whether it is sleeveless or made with sleeves, it is wise to observe several principles.

- ❁ Check garment and sleeve fit and alter the pattern accordingly.
- ❁ Carefully and accurately transfer all sleeve and armhole markings to the final fabric.
- ❁ Use proper growing techniques during construction.
- ❁ Whenever possible, finish the lower edge of the sleeve before attaching it to the garment.

4.5.1 Steps of Construction of sleeve

- ❁ Place two rows of stitching on the cap of the sleeve $\frac{1}{8}$ " away from the stitching line. The distance between the two lines will be $\frac{1}{4}$ ". Take care that the stitch size should be more than the usual one. Leave long threads at the starting & end of both the seams.
- ❁ Face right side to the right side and stitch at the side of the sleeve.
- ❁ Pull the threads and insert the sleeve inside the armhole of the bodice. Adjust





the size of the sleeve cap by pulling and releasing the thread. Put pins in position.

- ✿ Stitch the sleeve to the armhole.

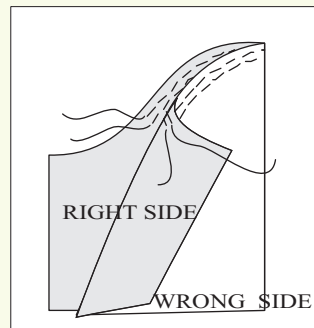

STEP-1

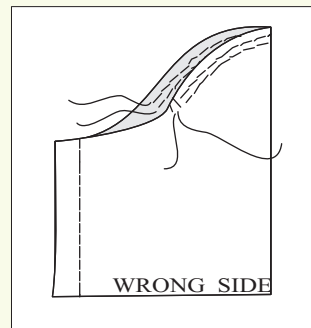

STEP-2

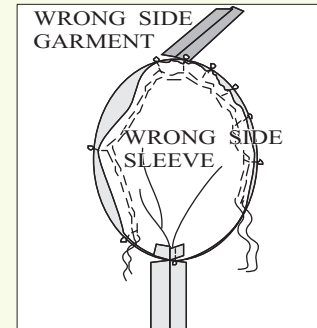

STEP-3

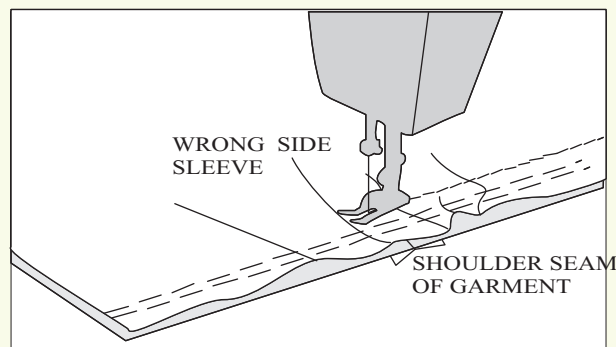

STEP-4

4.5.2 Cuffs

Cuffs actually consist of a cuff and a facing section, which may be cut all in one or may be in two pieces. Before starting cuff application, apply the type of placket, which is required for that particular sleeve and then complete the underarm sleeve seam. Prepare pleats or gathers at sleeve edge if any. Note the placement of the cuff end to placket edge.

One Piece Straight Cuff

Pattern Pieces (for sample)

1. One piece of upper and under cuff each.
2. Micro-dot interfacing for cuff.
3. Sleeve on which cuff will be applied along with sleeve placket.

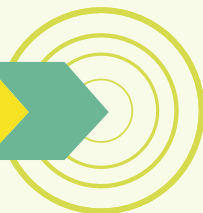



Steps of Construction

1. Fuse the wrong side of the upper cuff to interfacing, which can come to fold line or can be extended half inch beyond the fold line.
2. Turn the seam allowance of the upper cuff to the wrong side of the cuff and give top stitch at a distance of $\frac{1}{4}$ " or $\frac{3}{4}$ " as required.
3. Fold along fold line right side facing each other and pin the two ends from wrong side, stitch at a distance of half inch from both the sides. Chop off extra seam allowance near the edges.
4. Turn inside out and pull the corners.
5. Face wrong side of the sleeve to the right side of the under cuff, machine stitch in place.
6. Insert all the seam allowance into the cuff. Start machining at the edge, from the right side of the upper cuff on to the right side of the sleeve.
7. Optional top stitch at a distance of $\frac{1}{4}$ " all around the cuff edges.

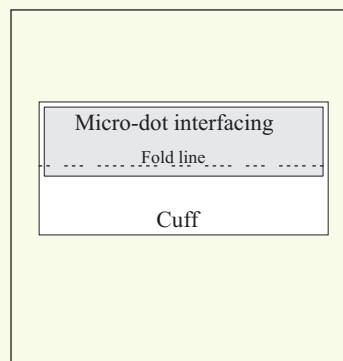

Step-1

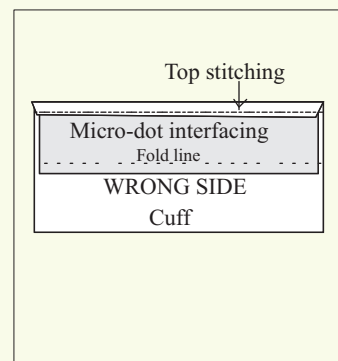

Step-2

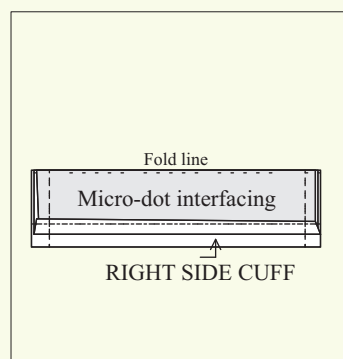

Step-3

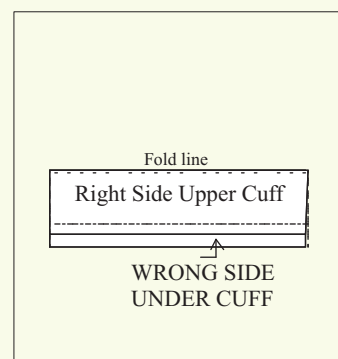

Step-4

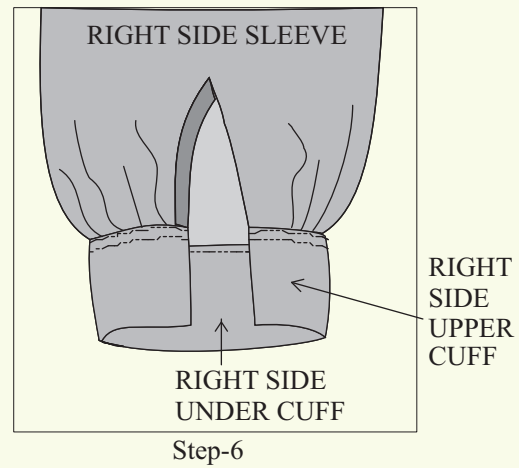
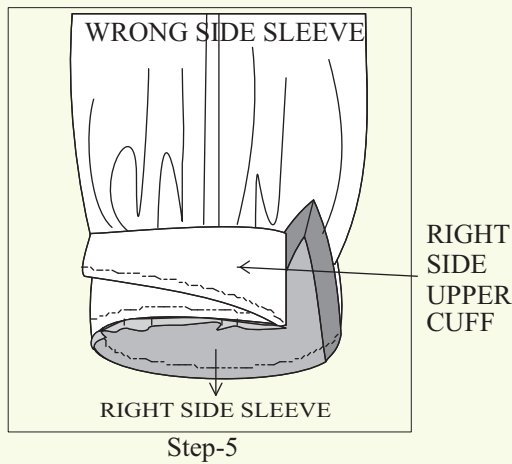

Activity

Collect pictures of garments with different kinds of sleeves. Place them in your folder.

Fill in the blanks

1. The sleeve _____ is attached to the armhole of the bodice by _____ gathering to ensure that edges meet.
2. A sleeve _____ is finished by gathering it to the armhole _____ to give it _____.
3. Place _____ of stitching on the cap of the sleeve _____ away from the _____ line.
4. The distance between the two seam lines will be _____.

Review Questions

1. Name 5 kinds of Sleeves.
2. Differentiate between Raglan and Kimono sleeve?

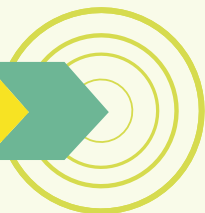



CONTINUOUS AND COMPREHENSIVE EVALUATION

CBSE

KNOW - AS YOU GROW

**Fashion
STUDIES**



Text Book

Fashion Studies **Fashion Studies**



CENTRAL BOARD OF SECONDARY EDUCATION

Shiksha Kendra, 2, Community Centre, Preet Vihar, Delhi-110 301 India